STORMWATER REPORT

The Residences at Bel Mont

McLean District - Zone 3

Olmsted Dr., Belmont, MA

PREPARED FOR

Northland Residential Corporation
80 Beharrell Road
Suite E
Concord, MA 01742
781.229.4704

PREPARED BY



101 Walnut Street
PO Box 9151
Watertown, MA 02471
617.924.1770

April 16, 2021
Revised September 23, 2021

Executive Summary

The Applicant, Northland Residential Corporation, is proposing to develop the property located within the McLean Hospital Zone 3 Overlay District located at Olmsted Road in Belmont, Massachusetts (the Site). The Project will be comprised of residential housing, consisting of single family and townhouse dwelling units with associated roadways and driveways, as well as multi-family rental housing with subgrade and surface parking areas.

Under existing conditions, the Site is primarily undeveloped woodlands, with one existing building and existing gravel parking area. The site is generally hilly, sloping down from north to south. The Site is uniquely located along a drainage divide, sending water to two separate water bodies. The western portion of the Site generally flows overland and is collected by the drainage system located within Olmsted Road. The Olmsted Road drainage system enters the municipal system and flows west, discharging downstream into Beaver Brook and ultimately entering the Charles River. The eastern portion of the site flows into an intermittent stream located off the eastern property line. This stream is collected by an existing pipe/headwall located at Pleasant Street, where it enters the municipal system and then ultimately discharges in the Boston Harbor.

As proposed, the stormwater management system will comply with Massachusetts Stormwater Standards, the Massachusetts MS4, the TMDL associated with the Upper/Middle Charles River, and the Town of Belmont Stormwater Management and Erosion Control Rules and Regulations. In general, stormwater from the proposed impervious surfaces will be collected by a closed drainage system and piped to either subsurface detention systems or subsurface sand filter systems to control peak runoff rates. Filtration vaults and subsurface sand filters will provide water quality treatment to the runoff.

In general, the proposed stormwater system as documented within this report will:

- Attenuate peak flows using subsurface detention systems outfitted with outlet control structures. The proposed stormwater system will reduce peak rates of runoff for the 2, 10, 25- and 100-year storms for all design points.
- Exceed phosphorous removal standards as required through the Massachusetts MS4 and Charles River Phosphorous TMDL.
- Comply with total suspended solids (TSS) removal requirements stated in the Massachusetts Stormwater Standards.

Table of Contents

Checklist for Stormwater Report	1
Stormwater Report Narrative	2
Project Description	2
Site Description	2
Existing Drainage Conditions.....	3
Proposed Drainage Conditions.....	4
Regulatory Compliance	11
Massachusetts Department of Environmental Protection (DEP) – Stormwater Management Standards	11
Standard 1: No New Untreated Discharges or Erosion to Wetlands.....	11
Standard 2: Peak Rate Attenuation	11
Standard 3: Stormwater Recharge.....	12
Standard 4: Water Quality	12
Standard 5: Land Uses with Higher Potential Pollutant Loads (LUHPPLs)	12
Standard 6: Critical Areas.....	13
Standard 7: Redevelopments and Other Projects Subject to the Standards only to the Maximum Extent Practicable	13
Standard 8: Construction Period Pollution Prevention and Erosion and Sedimentation Controls	13
Standard 9: Operation and Maintenance Plan.....	13
Standard 10: Prohibition of Illicit Discharges.....	13
Local Municipal Rules and Regulations.....	13
Appendices	
Appendix A: Standard 1 Computations and Supporting Information	1
Appendix B: Standard 2 Computations and Supporting Information	3
Appendix C: Standard 3 Computations and Supporting Documentation.....	7
Appendix D: Standard 4 Computations and Supporting Information	1
Appendix E: Standard 8 Supporting Information	1
Appendix F: Local Compliance	3

List of Figures

Table No.	Description
Figure 1	Site Location Map
Figure 2	Existing Drainage Conditions
Figure 3	Proposed Drainage Conditions
Figures 4A/4B	FEMA Maps

List of Tables

Table No.	Description	Page
Table 1	Existing Conditions Hydrologic Data.....	3
Table 2	Proposed Conditions Hydrologic Data.....	4
Table 3	Peak Discharge Rates (cfs*).....	12



Checklist for Stormwater Report



Checklist for Stormwater Report

A. Introduction

Important: When filling out forms on the computer, use only the tab key to move your cursor - do not use the return key.



A Stormwater Report must be submitted with the Notice of Intent permit application to document compliance with the Stormwater Management Standards. The following checklist is NOT a substitute for the Stormwater Report (which should provide more substantive and detailed information) but is offered here as a tool to help the applicant organize their Stormwater Management documentation for their Report and for the reviewer to assess this information in a consistent format. As noted in the Checklist, the Stormwater Report must contain the engineering computations and supporting information set forth in Volume 3 of the [Massachusetts Stormwater Handbook](#). The Stormwater Report must be prepared and certified by a Registered Professional Engineer (RPE) licensed in the Commonwealth.

The Stormwater Report must include:

- The Stormwater Checklist completed and stamped by a Registered Professional Engineer (see page 2) that certifies that the Stormwater Report contains all required submittals.¹ This Checklist is to be used as the cover for the completed Stormwater Report.
- Applicant/Project Name
- Project Address
- Name of Firm and Registered Professional Engineer that prepared the Report
- Long-Term Pollution Prevention Plan required by Standards 4-6
- Construction Period Pollution Prevention and Erosion and Sedimentation Control Plan required by Standard 8²
- Operation and Maintenance Plan required by Standard 9

In addition to all plans and supporting information, the Stormwater Report must include a brief narrative describing stormwater management practices, including environmentally sensitive site design and LID techniques, along with a diagram depicting runoff through the proposed BMP treatment train. Plans are required to show existing and proposed conditions, identify all wetland resource areas, NRCS soil types, critical areas, Land Uses with Higher Potential Pollutant Loads (LUHPPL), and any areas on the site where infiltration rate is greater than 2.4 inches per hour. The Plans shall identify the drainage areas for both existing and proposed conditions at a scale that enables verification of supporting calculations.

As noted in the Checklist, the Stormwater Management Report shall document compliance with each of the Stormwater Management Standards as provided in the Massachusetts Stormwater Handbook. The soils evaluation and calculations shall be done using the methodologies set forth in Volume 3 of the Massachusetts Stormwater Handbook.

To ensure that the Stormwater Report is complete, applicants are required to fill in the Stormwater Report Checklist by checking the box to indicate that the specified information has been included in the Stormwater Report. If any of the information specified in the checklist has not been submitted, the applicant must provide an explanation. The completed Stormwater Report Checklist and Certification must be submitted with the Stormwater Report.

¹ The Stormwater Report may also include the Illicit Discharge Compliance Statement required by Standard 10. If not included in the Stormwater Report, the Illicit Discharge Compliance Statement must be submitted prior to the discharge of stormwater runoff to the post-construction best management practices.

² For some complex projects, it may not be possible to include the Construction Period Erosion and Sedimentation Control Plan in the Stormwater Report. In that event, the issuing authority has the discretion to issue an Order of Conditions that approves the project and includes a condition requiring the proponent to submit the Construction Period Erosion and Sedimentation Control Plan before commencing any land disturbance activity on the site.



Checklist for Stormwater Report

B. Stormwater Checklist and Certification

The following checklist is intended to serve as a guide for applicants as to the elements that ordinarily need to be addressed in a complete Stormwater Report. The checklist is also intended to provide conservation commissions and other reviewing authorities with a summary of the components necessary for a comprehensive Stormwater Report that addresses the ten Stormwater Standards.

Note: Because stormwater requirements vary from project to project, it is possible that a complete Stormwater Report may not include information on some of the subjects specified in the Checklist. If it is determined that a specific item does not apply to the project under review, please note that the item is not applicable (N.A.) and provide the reasons for that determination.

A complete checklist must include the Certification set forth below signed by the Registered Professional Engineer who prepared the Stormwater Report.

Registered Professional Engineer's Certification

I have reviewed the Stormwater Report, including the soil evaluation, computations, Long-term Pollution Prevention Plan, the Construction Period Erosion and Sedimentation Control Plan (if included), the Long-term Post-Construction Operation and Maintenance Plan, the Illicit Discharge Compliance Statement (if included) and the plans showing the stormwater management system, and have determined that they have been prepared in accordance with the requirements of the Stormwater Management Standards as further elaborated by the Massachusetts Stormwater Handbook. I have also determined that the information presented in the Stormwater Checklist is accurate and that the information presented in the Stormwater Report accurately reflects conditions at the site as of the date of this permit application.

Registered Professional Engineer Block and Signature



Jeffrey Black

Jeffrey Black

9/23/2021

Signature and Date

Checklist

Project Type: Is the application for new development, redevelopment, or a mix of new and redevelopment?

- New development
- Redevelopment
- Mix of New Development and Redevelopment



Checklist for Stormwater Report

Checklist (continued)

LID Measures: Stormwater Standards require LID measures to be considered. Document what environmentally sensitive design and LID Techniques were considered during the planning and design of the project:

- No disturbance to any Wetland Resource Areas
- Site Design Practices (e.g. clustered development, reduced frontage setbacks)
- Reduced Impervious Area (Redevelopment Only)
- Minimizing disturbance to existing trees and shrubs
- LID Site Design Credit Requested:
 - Credit 1
 - Credit 2
 - Credit 3
- Use of "country drainage" versus curb and gutter conveyance and pipe
- Bioretention Cells (includes Rain Gardens)
- Constructed Stormwater Wetlands (includes Gravel Wetlands designs)
- Treebox Filter
- Water Quality Swale
- Grass Channel
- Green Roof
- Other (describe): _____

Standard 1: No New Untreated Discharges

- No new untreated discharges
- Outlets have been designed so there is no erosion or scour to wetlands and waters of the Commonwealth
- Supporting calculations specified in Volume 3 of the Massachusetts Stormwater Handbook included.



Checklist for Stormwater Report

Checklist (continued)

Standard 2: Peak Rate Attenuation

- Standard 2 waiver requested because the project is located in land subject to coastal storm flowage and stormwater discharge is to a wetland subject to coastal flooding.
- Evaluation provided to determine whether off-site flooding increases during the 100-year 24-hour storm.
- Calculations provided to show that post-development peak discharge rates do not exceed pre-development rates for the 2-year and 10-year 24-hour storms. If evaluation shows that off-site flooding increases during the 100-year 24-hour storm, calculations are also provided to show that post-development peak discharge rates do not exceed pre-development rates for the 100-year 24-hour storm.

Standard 3: Recharge Additional geotechnical testing indicates there is not potential for infiltration on site due to poor permeability rates. Recharge is not proposed for this project.

- Soil Analysis provided.
- Required Recharge Volume calculation provided.
- Required Recharge volume reduced through use of the LID site Design Credits.
- Sizing the infiltration, BMPs is based on the following method: Check the method used.
 - Static
 - Simple Dynamic
 - Dynamic Field¹
- Runoff from all impervious areas at the site discharging to the infiltration BMP.
- Runoff from all impervious areas at the site is *not* discharging to the infiltration BMP and calculations are provided showing that the drainage area contributing runoff to the infiltration BMPs is sufficient to generate the required recharge volume.
- Recharge BMPs have been sized to infiltrate the Required Recharge Volume.
- Recharge BMPs have been sized to infiltrate the Required Recharge Volume *only* to the maximum extent practicable for the following reason:
 - Site is comprised solely of C and D soils and/or bedrock at the land surface
 - M.G.L. c. 21E sites pursuant to 310 CMR 40.0000
 - Solid Waste Landfill pursuant to 310 CMR 19.000
 - Project is otherwise subject to Stormwater Management Standards only to the maximum extent practicable.
- Calculations showing that the infiltration BMPs will drain in 72 hours are provided.
- Property includes a M.G.L. c. 21E site or a solid waste landfill and a mounding analysis is included.

¹ 80% TSS removal is required prior to discharge to infiltration BMP if Dynamic Field method is used.



Checklist for Stormwater Report

Checklist (continued)

Standard 3: Recharge (continued)

- The infiltration BMP is used to attenuate peak flows during storms greater than or equal to the 10-year 24-hour storm and separation to seasonal high groundwater is less than 4 feet and a mounding analysis is provided.
- Documentation is provided showing that infiltration BMPs do not adversely impact nearby wetland resource areas.

Standard 4: Water Quality

The Long-Term Pollution Prevention Plan typically includes the following:

- Good housekeeping practices;
 - Provisions for storing materials and waste products inside or under cover;
 - Vehicle washing controls;
 - Requirements for routine inspections and maintenance of stormwater BMPs;
 - Spill prevention and response plans;
 - Provisions for maintenance of lawns, gardens, and other landscaped areas;
 - Requirements for storage and use of fertilizers, herbicides, and pesticides;
 - Pet waste management provisions;
 - Provisions for operation and management of septic systems;
 - Provisions for solid waste management;
 - Snow disposal and plowing plans relative to Wetland Resource Areas;
 - Winter Road Salt and/or Sand Use and Storage restrictions;
 - Street sweeping schedules;
 - Provisions for prevention of illicit discharges to the stormwater management system;
 - Documentation that Stormwater BMPs are designed to provide for shutdown and containment in the event of a spill or discharges to or near critical areas or from LUHPPL;
 - Training for staff or personnel involved with implementing Long-Term Pollution Prevention Plan;
 - List of Emergency contacts for implementing Long-Term Pollution Prevention Plan.
- A Long-Term Pollution Prevention Plan is attached to Stormwater Report and is included as an attachment to the Wetlands Notice of Intent.
 - Treatment BMPs subject to the 44% TSS removal pretreatment requirement and the one inch rule for calculating the water quality volume are included, and discharge:
 - is within the Zone II or Interim Wellhead Protection Area
 - is near or to other critical areas
 - is within soils with a rapid infiltration rate (greater than 2.4 inches per hour)
 - involves runoff from land uses with higher potential pollutant loads.
 - The Required Water Quality Volume is reduced through use of the LID site Design Credits.
 - Calculations documenting that the treatment train meets the 80% TSS removal requirement and, if applicable, the 44% TSS removal pretreatment requirement, are provided.



Checklist for Stormwater Report

Checklist (continued)

Standard 4: Water Quality (continued)

- The BMP is sized (and calculations provided) based on:
 - The $\frac{1}{2}$ " or 1" Water Quality Volume or
 - The equivalent flow rate associated with the Water Quality Volume and documentation is provided showing that the BMP treats the required water quality volume.
- The applicant proposes to use proprietary BMPs, and documentation supporting use of proprietary BMP and proposed TSS removal rate is provided. This documentation may be in the form of the propriety BMP checklist found in Volume 2, Chapter 4 of the Massachusetts Stormwater Handbook and submitting copies of the TARP Report, STEP Report, and/or other third party studies verifying performance of the proprietary BMPs.
- A TMDL exists that indicates a need to reduce pollutants other than TSS and documentation showing that the BMPs selected are consistent with the TMDL is provided.

Standard 5: Land Uses With Higher Potential Pollutant Loads (LUHPPLs) **Not Applicable**

- The NPDES Multi-Sector General Permit covers the land use and the Stormwater Pollution Prevention Plan (SWPPP) has been included with the Stormwater Report.
- The NPDES Multi-Sector General Permit covers the land use and the SWPPP will be submitted **prior to** the discharge of stormwater to the post-construction stormwater BMPs.
- The NPDES Multi-Sector General Permit does **not** cover the land use.
- LUHPPLs are located at the site and industry specific source control and pollution prevention measures have been proposed to reduce or eliminate the exposure of LUHPPLs to rain, snow, snow melt and runoff, and been included in the long term Pollution Prevention Plan.
- All exposure has been eliminated.
- All exposure has **not** been eliminated and all BMPs selected are on MassDEP LUHPPL list.
- The LUHPPL has the potential to generate runoff with moderate to higher concentrations of oil and grease (e.g. all parking lots with >1000 vehicle trips per day) and the treatment train includes an oil grit separator, a filtering bioretention area, a sand filter or equivalent.

Standard 6: Critical Areas **Not Applicable**

- The discharge is near or to a critical area and the treatment train includes only BMPs that MassDEP has approved for stormwater discharges to or near that particular class of critical area.
- Critical areas and BMPs are identified in the Stormwater Report.



Checklist for Stormwater Report

Checklist (continued)

Standard 7: Redevelopments and Other Projects Subject to the Standards only to the maximum extent practicable **Not Applicable**

- The project is subject to the Stormwater Management Standards only to the maximum Extent Practicable as a:
 - Limited Project
 - Small Residential Projects: 5-9 single family houses or 5-9 units in a multi-family development provided there is no discharge that may potentially affect a critical area.
 - Small Residential Projects: 2-4 single family houses or 2-4 units in a multi-family development with a discharge to a critical area
 - Marina and/or boatyard provided the hull painting, service and maintenance areas are protected from exposure to rain, snow, snow melt and runoff
 - Bike Path and/or Foot Path
 - Redevelopment Project
 - Redevelopment portion of mix of new and redevelopment.
- Certain standards are not fully met (Standard No. 1, 8, 9, and 10 must always be fully met) and an explanation of why these standards are not met is contained in the Stormwater Report.
- The project involves redevelopment and a description of all measures that have been taken to improve existing conditions is provided in the Stormwater Report. The redevelopment checklist found in Volume 2 Chapter 3 of the Massachusetts Stormwater Handbook may be used to document that the proposed stormwater management system (a) complies with Standards 2, 3 and the pretreatment and structural BMP requirements of Standards 4-6 to the maximum extent practicable and (b) improves existing conditions.

Standard 8: Construction Period Pollution Prevention and Erosion and Sedimentation Control

A Construction Period Pollution Prevention and Erosion and Sedimentation Control Plan must include the following information:

- Narrative;
 - Construction Period Operation and Maintenance Plan;
 - Names of Persons or Entity Responsible for Plan Compliance;
 - Construction Period Pollution Prevention Measures;
 - Erosion and Sedimentation Control Plan Drawings;
 - Detail drawings and specifications for erosion control BMPs, including sizing calculations;
 - Vegetation Planning;
 - Site Development Plan;
 - Construction Sequencing Plan;
 - Sequencing of Erosion and Sedimentation Controls;
 - Operation and Maintenance of Erosion and Sedimentation Controls;
 - Inspection Schedule;
 - Maintenance Schedule;
 - Inspection and Maintenance Log Form.
- A Construction Period Pollution Prevention and Erosion and Sedimentation Control Plan containing the information set forth above has been included in the Stormwater Report.



Checklist for Stormwater Report

Checklist (continued)

Standard 8: Construction Period Pollution Prevention and Erosion and Sedimentation Control (continued)

- The project is highly complex and information is included in the Stormwater Report that explains why it is not possible to submit the Construction Period Pollution Prevention and Erosion and Sedimentation Control Plan with the application. A Construction Period Pollution Prevention and Erosion and Sedimentation Control has **not** been included in the Stormwater Report but will be submitted **before** land disturbance begins.
- The project is **not** covered by a NPDES Construction General Permit.
- The project is covered by a NPDES Construction General Permit and a copy of the SWPPP is in the Stormwater Report.
- The project is covered by a NPDES Construction General Permit but no SWPPP been submitted. The SWPPP will be submitted BEFORE land disturbance begins.

Standard 9: Operation and Maintenance Plan

- The Post Construction Operation and Maintenance Plan is included in the Stormwater Report and includes the following information:
 - Name of the stormwater management system owners;
 - Party responsible for operation and maintenance; **TBD**
 - Schedule for implementation of routine and non-routine maintenance tasks;
 - Plan showing the location of all stormwater BMPs maintenance access areas; **on design plans**
 - Description and delineation of public safety features; **N/A**
 - Estimated operation and maintenance budget; and **TBD**
 - Operation and Maintenance Log Form.
- The responsible party is **not** the owner of the parcel where the BMP is located and the Stormwater Report includes the following submissions:
 - A copy of the legal instrument (deed, homeowner's association, utility trust or other legal entity) that establishes the terms of and legal responsibility for the operation and maintenance of the project site stormwater BMPs;
 - A plan and easement deed that allows site access for the legal entity to operate and maintain BMP functions.

Standard 10: Prohibition of Illicit Discharges

- The Long-Term Pollution Prevention Plan includes measures to prevent illicit discharges;
- An Illicit Discharge Compliance Statement is attached;
- NO Illicit Discharge Compliance Statement is attached but will be submitted **prior to** the discharge of any stormwater to post-construction BMPs.



Stormwater Report Narrative

This Stormwater Report has been prepared to demonstrate compliance with the Massachusetts Stormwater Management Standards in accordance with the Massachusetts Wetlands Protection Act Regulations (310 CMR 10.00). Additionally, this report demonstrates compliance with the Massachusetts MS4, the Final TMDL for Nutrients in the Upper/Middle Charles River, the Final Pathogen TMDL for the Charles River Watershed, the Town of Belmont Stormwater Management and Erosion Control Rules and Regulations, and the Town of Belmont Stormwater Management and Erosion Control Bylaw.

Project Description

The Applicant, Northland Residential Corporation, is proposing to construct residential development in Zone 3 adjacent to the McLean Hospital campus, located off Olmsted Drive. As proposed, the Project will entail the construction of single family or townhome structures, a multifamily apartment building with subgrade and surface parking, ancillary landscape improvements, roadways and driveways, and utility improvements to support this use.

Site Description

The Project Site is a 12.8-acre parcel of land (the Site) located at Olmsted Drive in Belmont, Massachusetts (see Figure 1). The Site is bounded by the McLean Hospital campus to the north, conservation restricted woodlands to the east and south, and residential homes to the west. See Figure 1, Site Locus Map.

According to the National Resources Conservation Service (NRCS), surface soils on the Site include Charlton-Hollis-Rock Outcrop Complex, Pittstown silt loam, Charlton fine sandy loam, and Narragansett-Hollis-Rock. NRCS classifies these on-site soils as Hydrologic Soil Groups (HSG) A and D.

Northeast Geotechnical, Inc. performed soils exploration and permeability testing within the footprints of proposed stormwater management systems and provided results in a Subsurface Exploration and Borehole Permeability Testing Report dated June 18, 2021. The results of the explorations indicate that the existing soils are not consistent with NRCS soils mapping. Four of the six permeability results indicate the infiltration rates less than the minimum 0.17 inch/hour requirement in the Stormwater Handbook. Based on guidance provided in the Part 630 Hydrology National Engineering Handbook, Chapter 7, Hydrologic Soils Group prepared by USDA and NRCS

and the on-site permeability testing results, VHB has revised the existing and proposed drainage models to utilize an HSG C.

Existing Drainage Conditions

The Site is generally undeveloped woodlands with hilly topography with one existing building surrounded by a grass. Figure 2 illustrates the existing drainage patterns on the Site. Currently, the Site is divided into seven drainage areas as stormwater runoff flows to four Design Points, which have been identified as DP-1, DP-2, DP-3 and DP-4.

Design Point 1 represents the portion of the Olmsted Road drainage system which captures and directs flows into a closed drainage system which in turn discharges into the municipal drainage system, Beaver Brook and ultimately the Charles River. There is an existing stormwater basin on site (1P), which receives some flows from a portion of Olmsted Drive and some of the pervious area of the site. This basin discharges into a wooded area, and ultimately overland flows into the Olmsted Road drainage system. The area draining towards DP-1 represents the portion of the site within the Charles River watershed and subject to its Nutrient and Pathogen TMDLs.

Design Point 2 represents the portion of the Olmsted Road Drainage system which captures and directs flows into a closed drainage system, which VHB understands from historic site documentation and reports as discharging into the municipal drainage system and ultimately the Boston Harbor.

Design Point 3 represents the portion of the Site which drains into the intermittent stream located off-site, beyond the eastern property line. This intermittent stream appears to terminate at a headwall at Pleasant Street, where flows enter the municipal drainage system and follow the same flow path as Design Point 2.

Design Point 4 represents the portion of the site that discharges into the Uphams Bowl area. A portion of the northwest corner of the site consisting of paved and pervious areas discharges via overland flow into the Uphams Bowl drainage system. There is an existing drainpipe that discharges through a headwall into the wooded area northwest of the Chapel and then flows overland to Uphams Bowl.

Table 1 below provides a summary of the existing conditions hydrologic data.

Table 1 Existing Conditions Hydrologic Data

Drainage Area	Discharge Location	Design Point	Area (Acres)	Curve Number	Time of Concentration (min)
EX-1A	1P/DP-1	DP-1	1.225	77	6.0
EX-1B	DP-1	DP-1	4.757	72	11.5
EX-1C	DP-1	DP-1	0.526	94	6.0
EX-2	DP-2	DP-2	1.947	75	6.0
EX-3A	DP-3	DP-3	3.277	74	15.7
EX-3B	DP-3	DP-3	0.317	92	6.0
EX-4	DP-4	DP-4	1.191	80	6.0

Proposed Drainage Conditions

Figure 3 illustrates the proposed “post construction” drainage conditions for the project. As shown, the Site will be divided into fifteen drainage areas that discharge stormwater to the four existing Design Points. Table 2 below provides a summary of the proposed conditions hydrologic data.

Table 2 Proposed Conditions Hydrologic Data

Drainage Area	Discharge Location	Design Point	Area (Acres)	Curve Number	Time of Concentration (min)
PR-1	DP-1	DP-1	1.483	81	6.0
PR-2	DP-4	DP-4	0.519	77	6.0
PR-3	2P	DP-1	3.321	89	6.0
PR-4	4P	DP-1	2.110	88	6.0
PR-5	1P	DP-3	1.800	95	6.0
PR-6	DP-3	DP-3	0.451	88	6.0
PR-7	3P	DP-3	0.846	94	6.0
PR-8	DP-3	DP-3	0.966	72	6.0
PR-9	3P	DP-3	0.261	97	6.0
PR-10	4P	DP-1	0.268	93	6.0
PR-11	DP-2	DP-2	0.479	73	6.0
PR-12	3P	DP-3	0.161	98	6.0
PR-13	4P	DP-1	0.242	98	6.0
PR-14	4P	DP-1	0.242	98	6.0
PR-15	4P	DP-1	0.091	98	6.0

The site design integrates a comprehensive stormwater management system that has been developed in accordance with the Massachusetts Stormwater Handbook and meets the performance standards laid out in the Massachusetts MS4, applicable TMDLs, and the Town of Belmont Stormwater Management Bylaw. The proposed stormwater management system has been designed to remove at least 85% TSS from proposed pavement areas. The system is also designed to remove greater than 60% total phosphorous from the Site post-construction and over 70% total phosphorous from the Site post-construction from areas discharging to the Charles River. Calculations can be found in the stormwater report appendices.

In general, stormwater from the proposed impervious surfaces will be collected by a closed drainage system and piped to subsurface detention or subsurface sand filter systems. These systems and their associated outlet control structures will control the peak rates of stormwater leaving the site. Water quality treatment will be provided by filtration vaults and subsurface sand filters. The filtration vaults (the Contech Stormfilter) are comprised of media filled cartridges that will treat the required water quality volume for phosphorous and TSS before discharging to its design point. The subsurface sand filters will provide water quality treatment by filtering runoff through sand before discharging to its design point.

Due to the generally poor permeability of existing soils and shallow bedrock VHB determined the site is classified as HSG C. The Stormwater Handbook suggests that infiltration in HSG C soils is to the maximum extent practical. Infiltration is not proposed for this site.

Figure 1 Site Locus Map

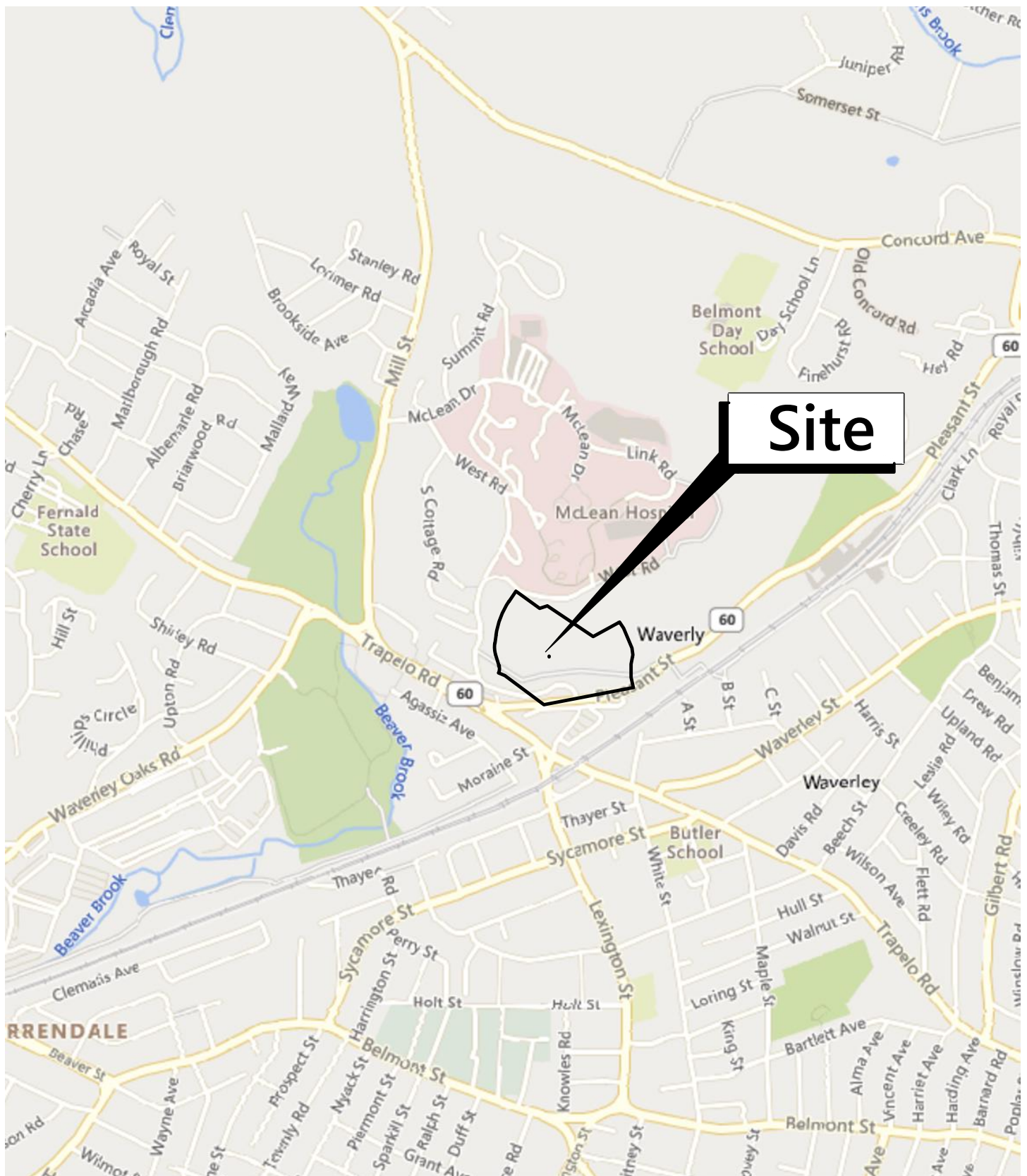

Site Location Map
Residences at Bel Mont
Olmsted Drive
Belmont, MA

Figure 1

3/11/2021

Figure 2 Existing Drainage Area

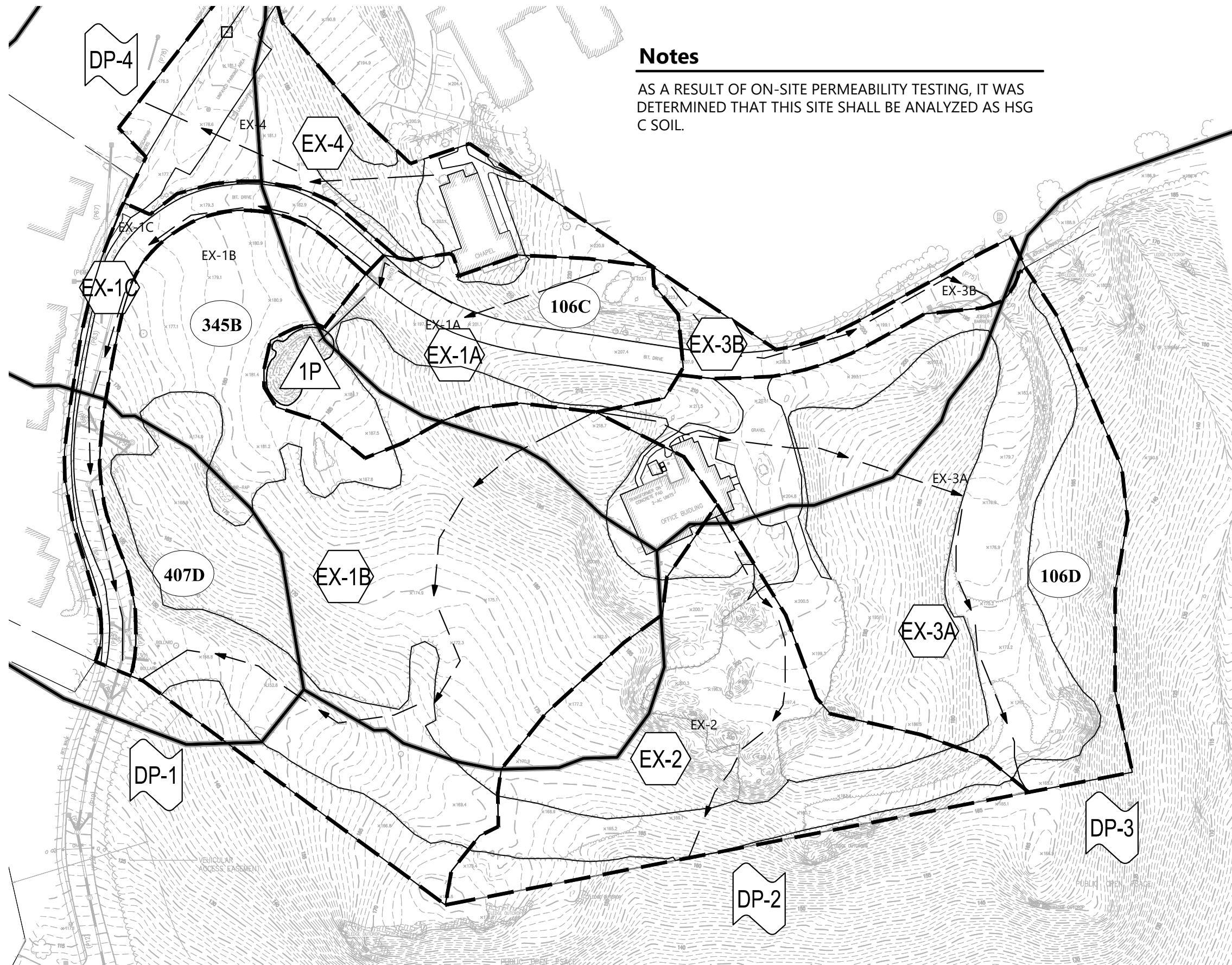

Notes

AS A RESULT OF ON-SITE PERMEABILITY TESTING, IT WAS DETERMINED THAT THIS SITE SHALL BE ANALYZED AS HSG C SOIL.

Legend

SYMBOLS

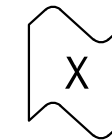

DESIGN POINT

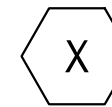

DRAINAGE AREA DESIGNATION

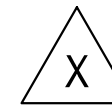

POND

LINETYPES



DRAINAGE AREA BOUNDARY

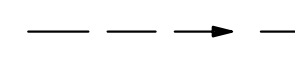

TIME OF CONCENTRATION FLOW LINE



SOIL TYPE BOUNDARY

SCS SOIL CLASSIFICATIONS



NARRAGANSETT-HOLLIS-ROCK OUTCROP COMPLEX, 3 TO 15 PERCENT SLOPES, HSG C



NARRAGANSETT-HOLLIS-ROCK OUTCROP COMPLEX, 15 TO 25 PERCENT SLOPES, HSG C



PITTSBURY SILT LOAM, 3 TO 8 PERCENT SLOPES, HSG C



CHARLTON FINE SANDY LOAM, 15 TO 25 PERCENT SLOPES, EXTREMELY STONY, HSG C

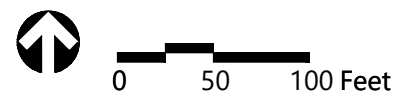
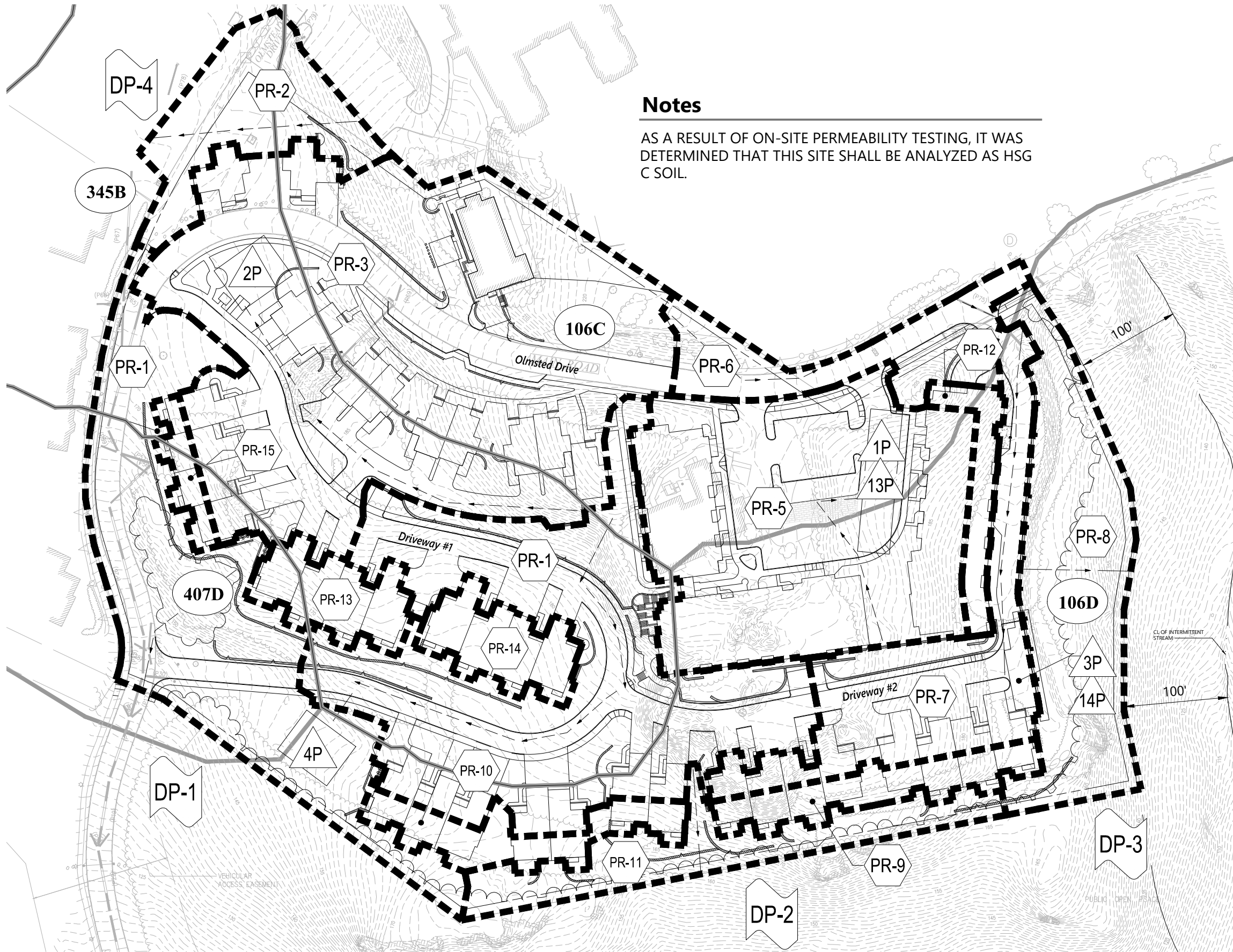

Figure 3 Proposed Drainage Area





Notes

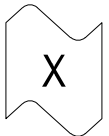
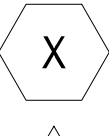

AS A RESULT OF ON-SITE PERMEABILITY TESTING, IT WAS DETERMINED THAT THIS SITE SHALL BE ANALYZED AS HSG C SOIL.

Legend





SYMBOLS

-  **DESIGN POINT**
-  **DRAINAGE AREA DESIGNATION**
-  **POND**

LINETYPES

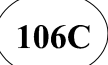
-  **DRAINAGE AREA BOUNDARY**
-  **TIME OF CONCENTRATION FLOW LINE**
-  **SOIL TYPE BOUNDARY**

SCS SOIL CLASSIFICATIONS

-  **106C** NARRAGANSETT-HOLLIS-ROCK OUTCROP COMPLEX, 3 TO 15 PERCENT SLOPES, HSG A
-  **106D** NARRAGANSETT-HOLLIS-ROCK OUTCROP COMPLEX, 15 TO 25 PERCENT SLOPES, HSG A
-  **345B** PITTS TOWN SILT LOAM, 3 TO 8 PERCENT SLOPES, HSG D
-  **407D** CHARLTON FINE SANDY LOAM, 15 TO 25 PERCENT SLOPES, EXTREMELY STONY, HSG D

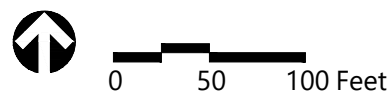

Figures 4A/4B FEMA Maps

National Flood Hazard Layer FIRMette



71°11'46"W 42°23'40"N

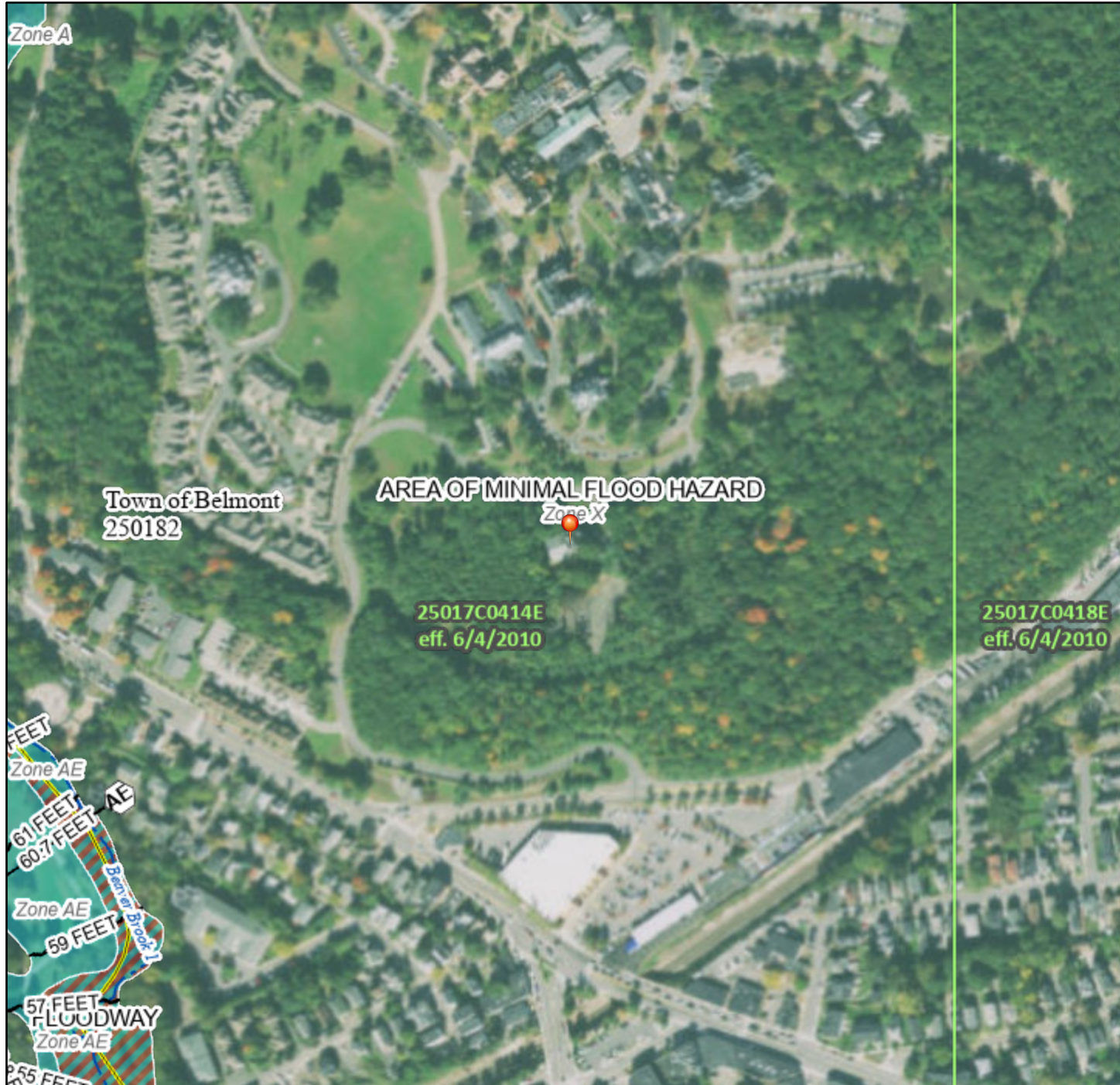

Legend

SEE FIS REPORT FOR DETAILED LEGEND AND INDEX MAP FOR FIRM PANEL LAYOUT

SPECIAL FLOOD HAZARD AREAS		Without Base Flood Elevation (BFE) <i>Zone A, V, A99</i>
		With BFE or Depth <i>Zone AE, AO, AH, VE, AR</i>
		Regulatory Floodway
OTHER AREAS OF FLOOD HAZARD		0.2% Annual Chance Flood Hazard, Areas of 1% annual chance flood with average depth less than one foot or with drainage areas of less than one square mile <i>Zone X</i>
		Future Conditions 1% Annual Chance Flood Hazard <i>Zone X</i>
		Area with Reduced Flood Risk due to Levee. See Notes. <i>Zone X</i>
		Area with Flood Risk due to Levee <i>Zone D</i>
OTHER AREAS		NO SCREEN Area of Minimal Flood Hazard <i>Zone X</i>
		Effective LOMRs
GENERAL STRUCTURES		Area of Undetermined Flood Hazard <i>Zone D</i>
		Channel, Culvert, or Storm Sewer
		Levee, Dike, or Floodwall
OTHER FEATURES		20.2 Cross Sections with 1% Annual Chance
		17.5 Water Surface Elevation
		Coastal Transect
		Base Flood Elevation Line (BFE)
		Limit of Study
MAP PANELS		Jurisdiction Boundary
		Coastal Transect Baseline
		Profile Baseline
		Hydrographic Feature
		Digital Data Available
		No Digital Data Available
		Unmapped
		The pin displayed on the map is an approximate point selected by the user and does not represent an authoritative property location.



This map complies with FEMA's standards for the use of digital flood maps if it is not void as described below. The basemap shown complies with FEMA's basemap accuracy standards

The flood hazard information is derived directly from the authoritative NFHL web services provided by FEMA. This map was exported on **3/11/2021 at 9:53 AM** and does not reflect changes or amendments subsequent to this date and time. The NFHL and effective information may change or become superseded by new data over time.

This map image is void if the one or more of the following map elements do not appear: basemap imagery, flood zone labels, legend, scale bar, map creation date, community identifiers, FIRM panel number, and FIRM effective date. Map images for unmapped and unmodernized areas cannot be used for regulatory purposes.

National Flood Hazard Layer FIRMMette



71°11'18"W 42°23'40"N

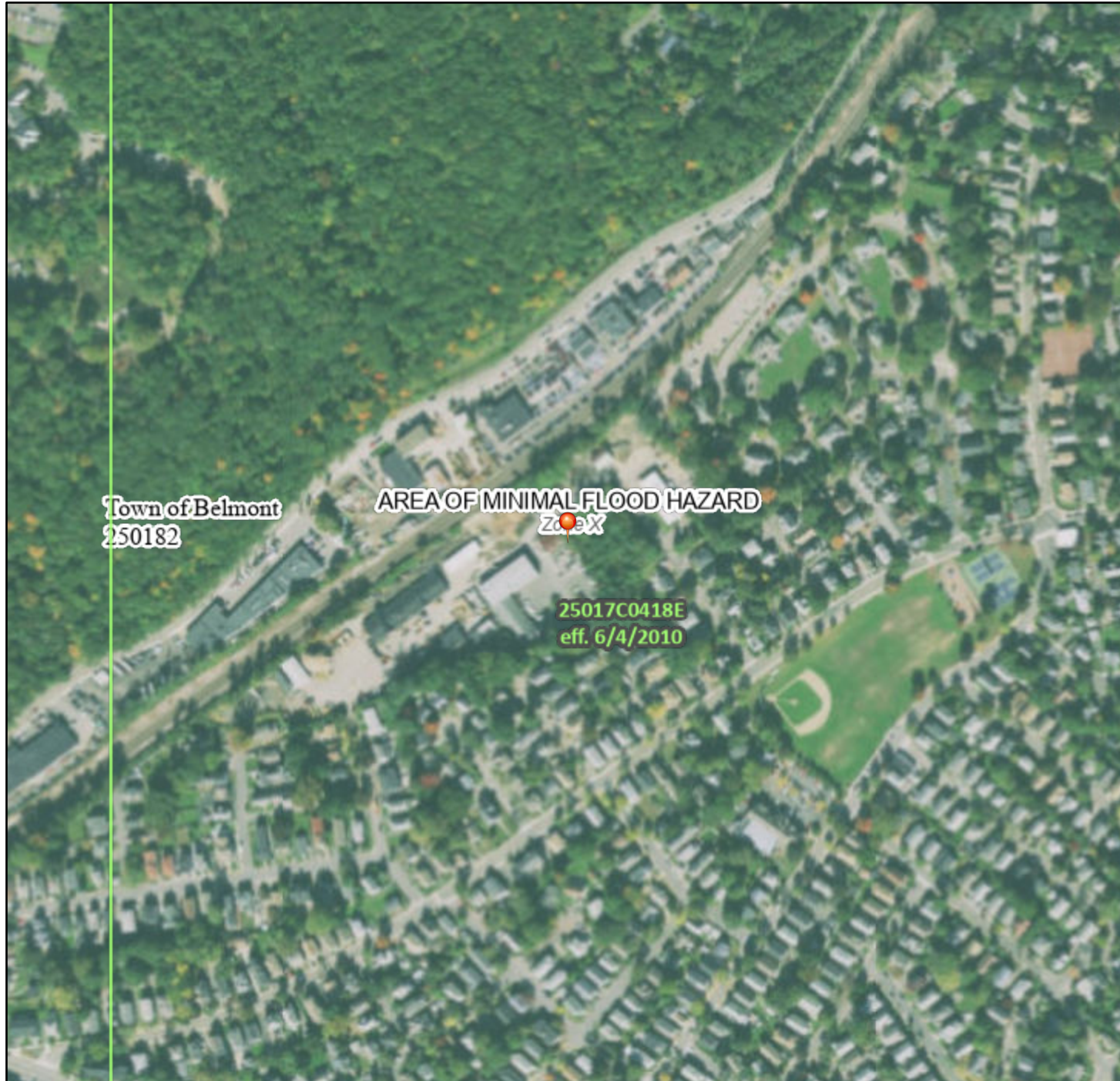

Legend

SEE FIS REPORT FOR DETAILED LEGEND AND INDEX MAP FOR FIRM PANEL LAYOUT

SPECIAL FLOOD HAZARD AREAS		Without Base Flood Elevation (BFE) <i>Zone A, V, A99</i>
		With BFE or Depth <i>Zone AE, AO, AH, VE, AR</i>
		Regulatory Floodway

OTHER AREAS OF FLOOD HAZARD		0.2% Annual Chance Flood Hazard, Areas of 1% annual chance flood with average depth less than one foot or with drainage areas of less than one square mile <i>Zone X</i>
		Future Conditions 1% Annual Chance Flood Hazard <i>Zone X</i>
		Area with Reduced Flood Risk due to Levee. See Notes. <i>Zone X</i>
		Area with Flood Risk due to Levee <i>Zone D</i>

OTHER AREAS		NO SCREEN Area of Minimal Flood Hazard <i>Zone X</i>
		Effective LOMRs
		Area of Undetermined Flood Hazard <i>Zone D</i>

GENERAL STRUCTURES		Channel, Culvert, or Storm Sewer
		Levee, Dike, or Floodwall

OTHER FEATURES		20.2 Cross Sections with 1% Annual Chance
		17.5 Water Surface Elevation
		Coastal Transect
		Base Flood Elevation Line (BFE)
		Limit of Study
		Jurisdiction Boundary
OTHER FEATURES		Coastal Transect Baseline
		Profile Baseline
		Hydrographic Feature

MAP PANELS		Digital Data Available
		No Digital Data Available
		Unmapped

The pin displayed on the map is an approximate point selected by the user and does not represent an authoritative property location.

This map complies with FEMA's standards for the use of digital flood maps if it is not void as described below. The basemap shown complies with FEMA's basemap accuracy standards

The flood hazard information is derived directly from the authoritative NFHL web services provided by FEMA. This map was exported on **3/11/2021 at 9:55 AM** and does not reflect changes or amendments subsequent to this date and time. The NFHL and effective information may change or become superseded by new data over time.

This map image is void if the one or more of the following map elements do not appear: basemap imagery, flood zone labels, legend, scale bar, map creation date, community identifiers, FIRM panel number, and FIRM effective date. Map images for unmapped and unmodernized areas cannot be used for regulatory purposes.



Regulatory Compliance

Massachusetts Department of Environmental Protection (DEP) – Stormwater Management Standards

As demonstrated below, the proposed Project fully complies with the DEP Stormwater Management Standards.

Standard 1: No New Untreated Discharges or Erosion to Wetlands

The Project has been designed to comply with Standard 1.

The Best Management Practices (BMPs) included in the proposed stormwater management system have been designed in accordance with the Massachusetts Stormwater Handbook. Supporting information and computations demonstrating that no new untreated discharges will result from the Project are presented through compliance with Standards 4 through 6.

All proposed Project stormwater outlets and conveyances have been designed to not cause erosion or scour to wetlands or receiving waters. Outlets from closed drainage systems have been designed with flared end sections and stone protection to dissipate discharge velocities. Overflows from BMP's that impound stormwater have been designed with stone to protect downgradient areas from erosion.

Computations and supporting information for the sizing and selection of materials used to protect from scour and erosion are included in Appendix A.

Standard 2: Peak Rate Attenuation

The Project has been designed to comply with Standard 2.

The rainfall-runoff response of the Site under existing and proposed conditions was analyzed for storm events with recurrence intervals of 2, 10, 25 and 100 years. The results of the analysis, as summarized in Table 3 below, indicate that there is no increase in peak discharge rates between the existing and proposed conditions for the 2, 10, 25 and 100-year storm events.

Computations and supporting information regarding the hydrologic modeling are included in Appendix B.

Table 3 Peak Discharge Rates (cfs*)

Design Point	2-year	10-year	25-year	100-year
DP-1: Olmstead Road Drainage System				
Existing	6.5	15.2	20.8	29.6
Proposed	6.3	13.1	17.8	24.4
DP-2: Olmstead Road to Pleasant Street				
Existing	2.5	5.8	8.1	11.7
Proposed	0.5	1.3	1.9	2.8
DP-3: Intermittent Stream				
Existing	3.3	7.8	10.8	15.7
Proposed	2.3	7.2	10.4	14.3
DP-4: Uphams Bowls				
Existing	2.0	4.2	5.6	7.9
Proposed	0.7	1.7	2.3	3.3

Standard 3: Stormwater Recharge

Northeast Geotechnical, Inc. performed soils exploration and permeability testing within the footprints of proposed stormwater management systems and provided results in a Subsurface Exploration and Borehole Permeability Testing Report dated June 18, 2021. The results of the explorations indicate that the existing soils are not consistent with NRCS soils mapping. Four of the six permeability results indicate the infiltration rates less than the minimum 0.17 inch/hour requirement in the Stormwater Handbook. Due to poor permeability rates, infiltration is not proposed. Soil evaluation (including Geotechnical Report excerpts) and supporting information are included in Appendix C.

Standard 4: Water Quality

The Project has been designed to comply with Standard 4.

The proposed stormwater management system implements a treatment train of BMPs that has been designed to provide 85% TSS removal of stormwater runoff from all proposed impervious.

Computations and supporting information, including the Long-Term Pollution Prevention Plan, are included in Appendix D.

Standard 5: Land Uses with Higher Potential Pollutant Loads (LUHPPLs)

The Project is not considered a LUHPPL.

Standard 6: Critical Areas

The Project will not discharge stormwater near or to a critical area.

Standard 7: Redevelopments and Other Projects Subject to the Standards only to the Maximum Extent Practicable

The Project has been designed to comply with all Stormwater Management Standards, with the exception of Standard 3. The project is seeking relief from Standard 3 due to poorly infiltrating soil on site. Refer directly to each Standard for applicable computations and supporting information demonstrating compliance with each.

Standard 8: Construction Period Pollution Prevention and Erosion and Sedimentation Controls

The Project will disturb approximately 12.8 acres of land and is therefore required to obtain coverage under the Environmental Protection Agency (EPA) National Pollutant Discharge Elimination System (NPDES) Construction General Permit. As required under this permit, a Stormwater Pollution Prevention Plan (SWPPP) will be developed and submitted before land disturbance begins. Recommended construction period pollution prevention and erosion and sedimentation controls to be finalized in the SWPPP are included in Appendix F.

Standard 9: Operation and Maintenance Plan

In compliance with Standard 9, a Post Construction Stormwater Operation and Maintenance (O&M) Plan has been developed for the Project. The O&M Plan is included in Appendix D as part of the Long-Term Pollution Prevention Plan.

Standard 10: Prohibition of Illicit Discharges

Sanitary sewer and storm drainage structures remaining from previous development which are part of the redevelopment area will be removed or will be incorporated into updated sanitary sewer and separate stormwater sewer systems. The design plans submitted with this report have been designed so that the components included therein are in full compliance with current standards. No statement is made regarding the drainage system in portions of the site not included in the redevelopment project area. The Long-Term Pollution Prevention Plan includes measures to prevent illicit discharges.

Local Municipal Rules and Regulations

The proposed stormwater management system is designed to be in compliance with the Town of Belmont Stormwater Management and Erosion Control Rules and Regulations. The system achieves the treatment requirements as stated in the Massachusetts MS4 and the Massachusetts Stormwater Standards, as required by the local bylaw. The design criteria as stated in section 34.6.4.1 of the Belmont Stormwater Management and Erosion Control Bylaw are listed below:

a) Compliance with all applicable provisions of the Stormwater Management Standards, regardless of the proximity of the development to resource areas or their buffer zones, as defined by the Wetlands Protection Act, M.G.L. c. 131, § 40 and its implementing regulations.

The Site stormwater management system meets all Stormwater Management Standards, see appendices and narrative herein for details and calculations.

(b) Erosion and sediment controls must be implemented to prevent adverse impacts during disturbance and construction activities.

The project will employ robust erosion and sedimentation controls throughout the course of construction, and a SWPPP will be filed before construction which will govern the controls during construction. A recommended construction period BMP checklist is included in the appendices of this report, and the site plans show the minimum required erosion and sedimentation controls as well as notes stating minimum required measures to control the site during construction.

(c) There shall be no change to the existing conditions of abutting properties from any increase in volume of stormwater runoff or from erosion, silting, flooding, sedimentation or impacts to wetlands, ground water levels or wells.

The stormwater management system has been designed to reduce peak rates of runoff for the 2, 10, 25- and 100-year storms. No increased rate of stormwater will be directed to any abutters.

(d) When any proposed discharge may have an impact upon streams, wetlands and/or storm sewers, the OCD may require minimization or elimination of this impact based on site conditions and existing stormwater system capacity

All stormwater outfall locations have been designed with stone to avoid erosion and sedimentation, as well as impacts to the intermittent stream located east of the site.

Appendix A: Standard 1 Computations and Supporting Information

- › Stone outlet protection for pipe ends (See Virginia Erosion and Sediment Control Handbook, Chapter 3.18)



Outfall Riprap Sizing and Velocity Calculations

Project	Residences at Bel Mont	Project #	13555.04
Calculated by	GB	Date	9.9.21
Checked by		Date	

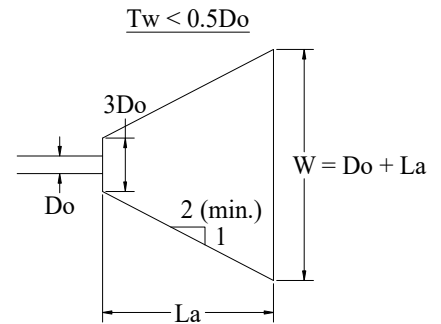
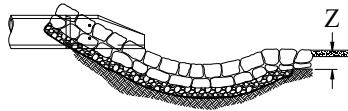
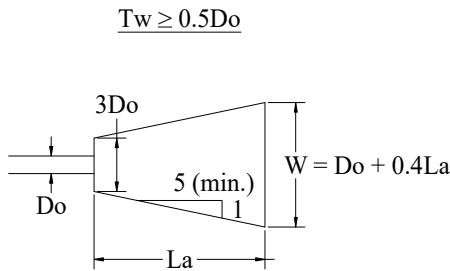

OUTLET DESCRIPTION:

		FES-1500	FES-1700			
Design Storm	(yr)	25	25			
Flow / Discharge (Q)	(cfs)	2.2	3.3			
Defined Channel ?	-	NO	NO			
Defined Channel Width	(ft)	0	0			
Outlet Pipe Diameter (D _O)	(in)	15	15			
Tailwater Condition (T _w)	(ft)	TW < 0.5D	TW < 0.5D			
Apron Length (L _A)	(ft)	10	10			
Apron Width at Outlet (3D _O)	(ft)	3.75	3.75			
Apron Width at End (W)	(ft)	11.3	11.3			
Median Stone Diameter (d ₅₀)	(in)	6	6			
Largest Stone Diameter	(in)	9	9			
Apron Depth (Z)	(in)	13.5	13.5			

Apron Length (L_A): Length = From Virginia DCR Handbook - Plate 3.18-3 if T_w < 0.5D
 Length = From Virginia DCR Handbook - Plate 3.18-4 if T_w ≥ 0.5D

Apron Width at Outlet (3D_O): Width = 3 x pipe dia. (or width of channel)

Apron Width at End (W): Width = dia. + apron length if T_w < 0.5D
 Width = dia. + 0.4 x apron length if T_w ≥ 0.5D
 or apron width = channel width if a well defined channel exists

Rock Riprap: Median Diameter (d₅₀) = From Virginia DCR Handbook - Plate 3.18-3 or 4
 Largest stone dia = 1.5 x d₅₀

Apron Depth (Z): 6" or 1.5 x largest stone dia

Appendix B: Standard 2 Computations and Supporting Information

The rainfall-runoff response of the Site under existing and proposed conditions was evaluated for storm events with recurrence intervals of 2, 10, 25 and 100-years. Rainfall volumes used for this analysis were based on the Natural Resources Conservation Service (NRCS) Type III, 24-hour storm and NOAA Atlas 14 precipitation depths for the site: 3.25, 5.14, 6.31, and 8.13 inches, respectively. Runoff coefficients for the pre- and post-development conditions, as previously shown in Tables 1 and 2 respectively, were determined using NRCS Technical Release 55 (TR-55) methodology as provided in HydroCAD. Drainage areas used in the analyses were described in previous sections and shown on Figures 2 and 3. The HydroCAD model is based on the NRCS Technical Release 20 (TR-20) Model for Project Formulation Hydrology.

NOAA Atlas 14 Rainfall Data



NOAA Atlas 14, Volume 10, Version 3
Location name: Belmont, Massachusetts, USA*
Latitude: 42.3904°, Longitude: -71.1907°
Elevation: 206.15 ft**
* source: ESRI Maps
** source: USGS



POINT PRECIPITATION FREQUENCY ESTIMATES

Sanja Perica, Sandra Pavlovic, Michael St. Laurent, Carl Trypaluk, Dale Unruh, Orlan Wilhite

NOAA, National Weather Service, Silver Spring, Maryland

[PF_tabular](#) | [PF_graphical](#) | [Maps & aeriels](#)

PF tabular

PDS-based point precipitation frequency estimates with 90% confidence intervals (in inches)¹										
Duration	Average recurrence interval (years)									
	1	2	5	10	25	50	100	200	500	1000
5-min	0.303 (0.236-0.387)	0.373 (0.290-0.477)	0.487 (0.377-0.627)	0.582 (0.448-0.753)	0.713 (0.533-0.968)	0.810 (0.594-1.13)	0.914 (0.653-1.32)	1.04 (0.697-1.53)	1.22 (0.788-1.86)	1.37 (0.867-2.13)
10-min	0.429 (0.334-0.548)	0.528 (0.410-0.676)	0.690 (0.534-0.887)	0.825 (0.635-1.07)	1.01 (0.754-1.37)	1.15 (0.841-1.60)	1.30 (0.925-1.88)	1.47 (0.988-2.16)	1.72 (1.12-2.63)	1.94 (1.23-3.03)
15-min	0.505 (0.393-0.645)	0.621 (0.483-0.795)	0.811 (0.629-1.04)	0.970 (0.747-1.25)	1.19 (0.888-1.61)	1.35 (0.990-1.88)	1.52 (1.09-2.21)	1.73 (1.16-2.55)	2.03 (1.31-3.10)	2.28 (1.44-3.56)
30-min	0.688 (0.535-0.879)	0.849 (0.660-1.09)	1.11 (0.861-1.43)	1.33 (1.02-1.72)	1.63 (1.22-2.22)	1.86 (1.36-2.58)	2.10 (1.50-3.05)	2.38 (1.60-3.52)	2.82 (1.83-4.32)	3.20 (2.02-4.99)
60-min	0.871 (0.678-1.11)	1.08 (0.837-1.38)	1.41 (1.09-1.81)	1.69 (1.30-2.19)	2.08 (1.55-2.83)	2.36 (1.73-3.29)	2.67 (1.92-3.89)	3.04 (2.05-4.49)	3.62 (2.34-5.53)	4.11 (2.60-6.42)
2-hr	1.14 (0.893-1.45)	1.40 (1.10-1.79)	1.83 (1.43-2.34)	2.19 (1.70-2.81)	2.68 (2.02-3.63)	3.04 (2.26-4.23)	3.44 (2.49-5.00)	3.94 (2.66-5.76)	4.72 (3.06-7.15)	5.40 (3.43-8.34)
3-hr	1.33 (1.05-1.69)	1.64 (1.28-2.07)	2.13 (1.67-2.71)	2.54 (1.98-3.25)	3.11 (2.35-4.19)	3.53 (2.62-4.88)	3.98 (2.90-5.77)	4.56 (3.09-6.64)	5.48 (3.56-8.25)	6.28 (3.99-9.64)
6-hr	1.73 (1.37-2.17)	2.11 (1.67-2.66)	2.74 (2.16-3.46)	3.27 (2.56-4.14)	3.99 (3.04-5.33)	4.52 (3.38-6.19)	5.10 (3.72-7.31)	5.83 (3.96-8.41)	6.98 (4.56-10.4)	7.98 (5.09-12.1)
12-hr	2.19 (1.75-2.73)	2.68 (2.13-3.35)	3.48 (2.76-4.37)	4.15 (3.27-5.23)	5.07 (3.88-6.71)	5.74 (4.31-7.79)	6.48 (4.74-9.19)	7.39 (5.04-10.6)	8.81 (5.77-13.0)	10.0 (6.43-15.1)
24-hr	2.62 (2.11-3.25)	3.25 (2.61-4.04)	4.28 (3.42-5.33)	5.14 (4.08-6.43)	6.31 (4.86-8.32)	7.18 (5.42-9.69)	8.13 (5.99-11.5)	9.32 (6.38-13.2)	11.2 (7.35-16.4)	12.8 (8.22-19.1)
2-day	2.99 (2.42-3.68)	3.78 (3.05-4.66)	5.07 (4.08-6.27)	6.14 (4.91-7.63)	7.62 (5.91-9.99)	8.69 (6.63-11.7)	9.89 (7.37-13.9)	11.4 (7.86-16.1)	13.9 (9.19-20.2)	16.2 (10.4-23.9)
3-day	3.28 (2.66-4.02)	4.14 (3.35-5.07)	5.53 (4.46-6.81)	6.69 (5.36-8.27)	8.28 (6.45-10.8)	9.43 (7.22-12.6)	10.7 (8.03-15.1)	12.4 (8.55-17.4)	15.2 (10.0-21.9)	17.6 (11.4-25.9)
4-day	3.56 (2.89-4.35)	4.44 (3.61-5.43)	5.88 (4.76-7.22)	7.07 (5.69-8.73)	8.72 (6.81-11.3)	9.92 (7.61-13.2)	11.3 (8.44-15.7)	13.0 (8.97-18.1)	15.9 (10.5-22.8)	18.4 (11.9-26.9)
7-day	4.31 (3.53-5.24)	5.23 (4.27-6.36)	6.73 (5.48-8.21)	7.97 (6.45-9.78)	9.69 (7.60-12.5)	10.9 (8.42-14.5)	12.3 (9.26-17.0)	14.1 (9.79-19.5)	17.1 (11.3-24.3)	19.7 (12.7-28.5)
10-day	5.01 (4.11-6.06)	5.95 (4.88-7.21)	7.49 (6.12-9.10)	8.76 (7.12-10.7)	10.5 (8.27-13.5)	11.8 (9.10-15.5)	13.2 (9.92-18.1)	15.0 (10.4-20.6)	17.9 (11.9-25.4)	20.4 (13.2-29.5)
20-day	7.01 (5.80-8.43)	8.03 (6.63-9.66)	9.70 (7.98-11.7)	11.1 (9.06-13.4)	13.0 (10.2-16.4)	14.4 (11.1-18.6)	15.9 (11.8-21.2)	17.7 (12.4-24.0)	20.2 (13.5-28.3)	22.3 (14.5-31.8)
30-day	8.66 (7.20-10.4)	9.75 (8.08-11.7)	11.5 (9.52-13.8)	13.0 (10.7-15.7)	15.0 (11.8-18.8)	16.6 (12.7-21.1)	18.1 (13.4-23.8)	19.8 (13.9-26.7)	22.1 (14.8-30.7)	23.9 (15.6-33.9)
45-day	10.7 (8.95-12.8)	11.9 (9.90-14.2)	13.8 (11.4-16.5)	15.3 (12.6-18.4)	17.5 (13.8-21.7)	19.2 (14.7-24.1)	20.8 (15.4-26.9)	22.4 (15.8-30.0)	24.5 (16.5-33.8)	26.0 (17.0-36.6)
60-day	12.5 (10.4-14.8)	13.7 (11.4-16.3)	15.7 (13.0-18.7)	17.3 (14.3-20.7)	19.5 (15.5-24.1)	21.3 (16.4-26.7)	23.0 (17.0-29.5)	24.6 (17.4-32.7)	26.5 (17.9-36.5)	27.9 (18.2-39.1)

¹ Precipitation frequency (PF) estimates in this table are based on frequency analysis of partial duration series (PDS). Numbers in parenthesis are PF estimates at lower and upper bounds of the 90% confidence interval. The probability that precipitation frequency estimates (for a given duration and average recurrence interval) will be greater than the upper bound (or less than the lower bound) is 5%. Estimates at upper bounds are not checked against probable maximum precipitation (PMP) estimates and may be higher than currently valid PMP values. Please refer to NOAA Atlas 14 document for more information.

[Back to Top](#)

PF graphical

PDS-based depth-duration-frequency (DDF) curves
 Latitude: 42.3904°, Longitude: -71.1907°

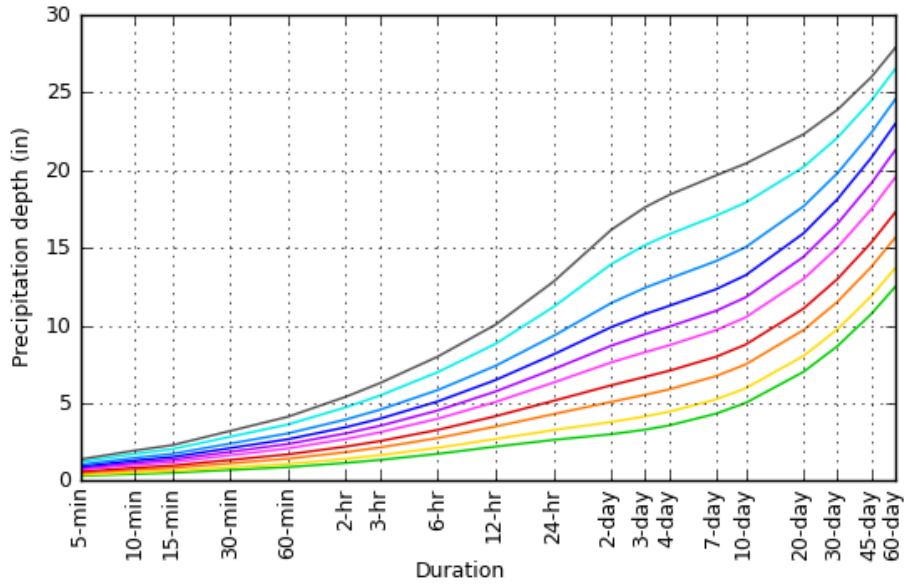

Average recurrence interval (years)
1
2
5
10
25
50
100
200
500
1000

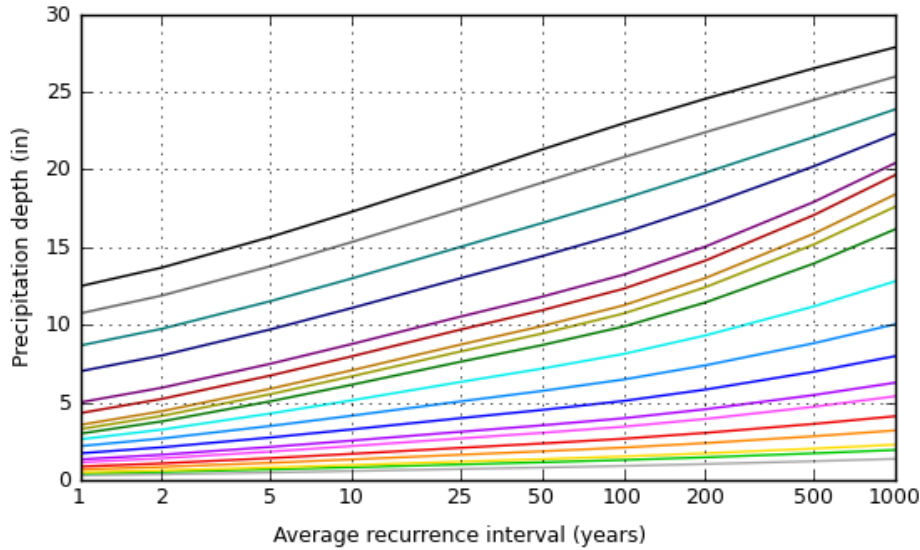

Duration	
5-min	2-day
10-min	3-day
15-min	4-day
30-min	7-day
60-min	10-day
2-hr	20-day
3-hr	30-day
6-hr	45-day
12-hr	60-day
24-hr	

[Back to Top](#)

Maps & aerials

Small scale terrain

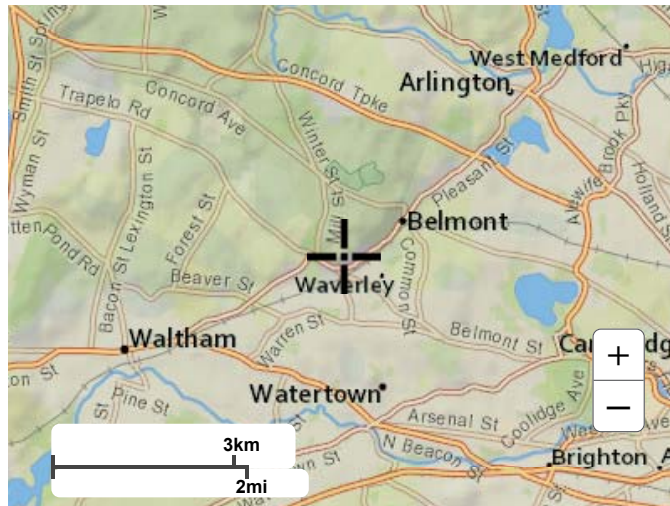

Large scale terrain

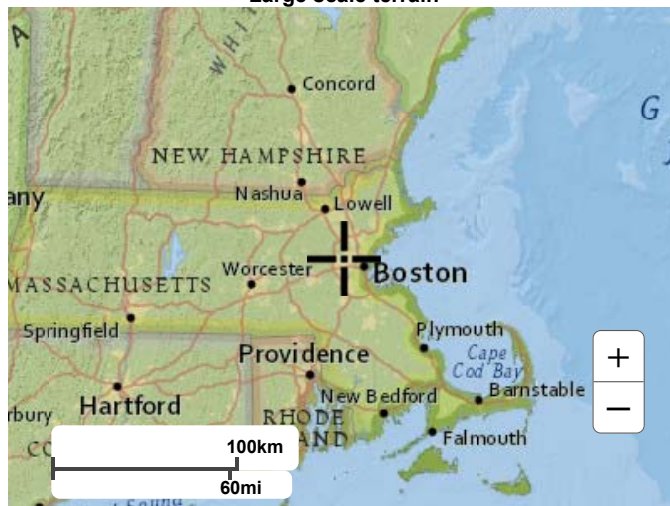

Large scale map



Large scale aerial

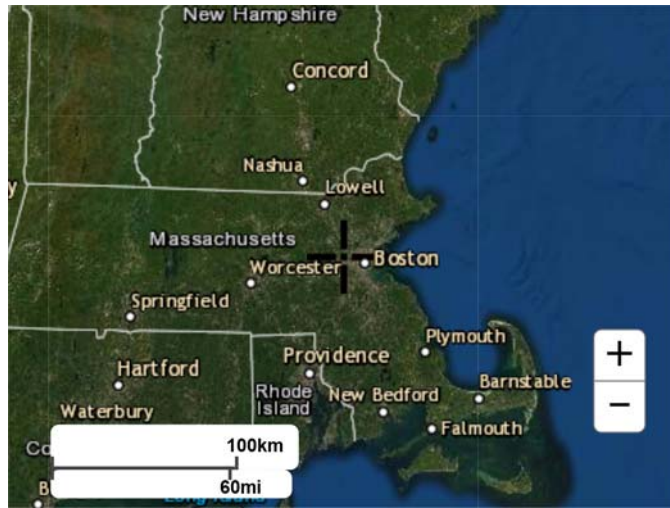

[Back to Top](#)

[US Department of Commerce](#)
[National Oceanic and Atmospheric Administration](#)
[National Weather Service](#)
[National Water Center](#)
1325 East West Highway
Silver Spring, MD 20910
Questions?: HDSC.Questions@noaa.gov

[Disclaimer](#)

HydroCAD Analysis: Existing Conditions

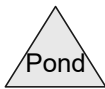
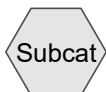
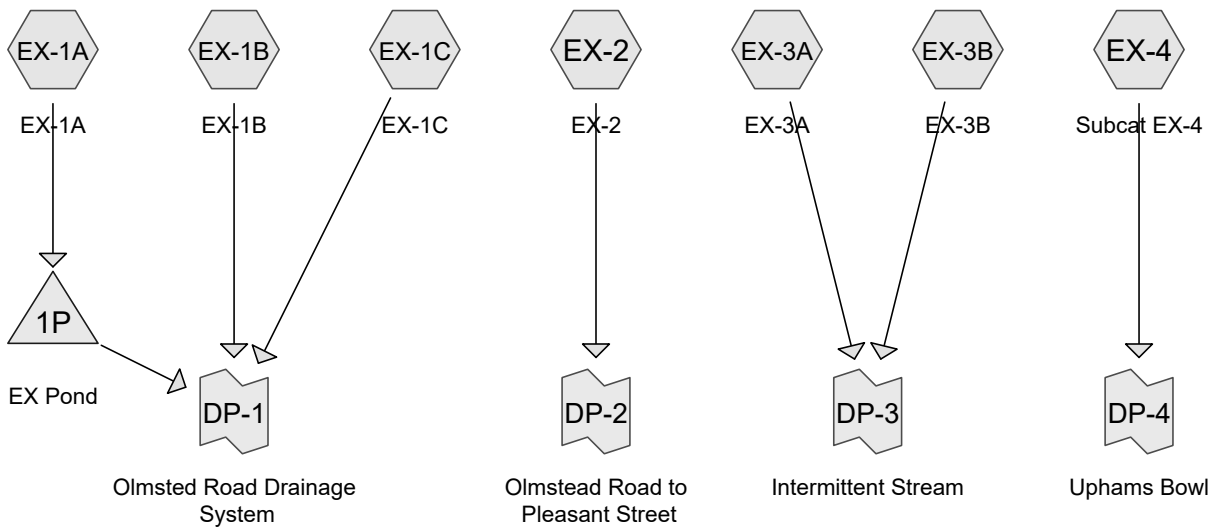

13555.04-EX

Prepared by VHB

HydroCAD® 10.10-5a s/n 01038 © 2020 HydroCAD Software Solutions LLC

Existing Conditions
Type III 24-hr 2-yr, 24-hr Rainfall=3.25"

Printed 9/23/2021

Time span=0.00-72.00 hrs, dt=0.01 hrs, 7201 points
 Runoff by SCS TR-20 method, UH=SCS, Weighted-CN
 Reach routing by Stor-Ind+Trans method - Pond routing by Stor-Ind method

SubcatchmentEX-1A: EX-1A Runoff Area=1.23 ac 15.48% Impervious Runoff Depth=1.25"
 Tc=6.0 min CN=77 Runoff=1.7 cfs 0.127 af

SubcatchmentEX-1B: EX-1B Runoff Area=4.76 ac 2.21% Impervious Runoff Depth=0.96"
 Flow Length=670' Tc=11.5 min CN=72 Runoff=4.1 cfs 0.381 af

SubcatchmentEX-1C: EX-1C Runoff Area=0.53 ac 85.00% Impervious Runoff Depth=2.59"
 Tc=6.0 min CN=94 Runoff=1.5 cfs 0.114 af

SubcatchmentEX-2: EX-2 Runoff Area=1.95 ac 0.11% Impervious Runoff Depth=1.13"
 Tc=6.0 min CN=75 Runoff=2.5 cfs 0.183 af

SubcatchmentEX-3A: EX-3A Runoff Area=3.28 ac 1.06% Impervious Runoff Depth=1.07"
 Flow Length=665' Tc=15.7 min CN=74 Runoff=2.9 cfs 0.292 af

SubcatchmentEX-3B: EX-3B Runoff Area=0.32 ac 73.77% Impervious Runoff Depth=2.40"
 Tc=6.0 min CN=92 Runoff=0.9 cfs 0.063 af

SubcatchmentEX-4: Subcat EX-4 Runoff Area=1.19 ac 29.04% Impervious Runoff Depth=1.44"
 Tc=6.0 min CN=80 Runoff=2.0 cfs 0.143 af

Pond 1P: EX Pond Peak Elev=179.10' Storage=887 cf Inflow=1.7 cfs 0.127 af
 Outflow=1.3 cfs 0.121 af

Link DP-1: Olmsted Road Drainage System Inflow=6.5 cfs 0.616 af
 Primary=6.5 cfs 0.616 af

Link DP-2: Olmstead Road to Pleasant Street Inflow=2.5 cfs 0.183 af
 Primary=2.5 cfs 0.183 af

Link DP-3: Intermittent Stream Inflow=3.3 cfs 0.356 af
 Primary=3.3 cfs 0.356 af

Link DP-4: Uphams Bowl Inflow=2.0 cfs 0.143 af
 Primary=2.0 cfs 0.143 af

Total Runoff Area = 13.24 ac Runoff Volume = 1.303 af Average Runoff Depth = 1.18"
89.74% Pervious = 11.88 ac 10.26% Impervious = 1.36 ac

13555.04-EX

Prepared by VHB

HydroCAD® 10.10-5a s/n 01038 © 2020 HydroCAD Software Solutions LLC

Existing Conditions
Type III 24-hr 2-yr, 24-hr Rainfall=3.25"

Printed 9/23/2021

Summary for Subcatchment EX-1A: EX-1A

Runoff = 1.7 cfs @ 12.09 hrs, Volume= 0.127 af, Depth= 1.25"

Runoff by SCS TR-20 method, UH=SCS, Weighted-CN, Time Span= 0.00-72.00 hrs, dt= 0.01 hrs
Type III 24-hr 2-yr, 24-hr Rainfall=3.25"

Area (ac)	CN	Description
0.77	74	>75% Grass cover, Good, HSG C
0.18	98	Paved parking, HSG C
0.00	98	Roofs, HSG C
0.01	98	Unconnected pavement, HSG C
0.27	70	Woods, Good, HSG C
1.23	77	Weighted Average
1.04		84.52% Pervious Area
0.19		15.48% Impervious Area
0.01		2.73% Unconnected

Tc (min)	Length (feet)	Slope (ft/ft)	Velocity (ft/sec)	Capacity (cfs)	Description
6.0					Direct Entry,

Summary for Subcatchment EX-1B: EX-1B

Runoff = 4.1 cfs @ 12.17 hrs, Volume= 0.381 af, Depth= 0.96"

Runoff by SCS TR-20 method, UH=SCS, Weighted-CN, Time Span= 0.00-72.00 hrs, dt= 0.01 hrs
Type III 24-hr 2-yr, 24-hr Rainfall=3.25"

Area (ac)	CN	Description
* 0.00	0	, HSG C
1.87	74	>75% Grass cover, Good, HSG C
0.01	89	Gravel roads, HSG C
0.00	98	Paved parking, HSG C
0.10	98	Roofs, HSG C
2.77	70	Woods, Good, HSG C
4.76	72	Weighted Average
4.65		97.79% Pervious Area
0.10		2.21% Impervious Area

13555.04-EX

Prepared by VHB

HydroCAD® 10.10-5a s/n 01038 © 2020 HydroCAD Software Solutions LLC

Existing Conditions
Type III 24-hr 2-yr, 24-hr Rainfall=3.25"

Printed 9/23/2021

Tc (min)	Length (feet)	Slope (ft/ft)	Velocity (ft/sec)	Capacity (cfs)	Description
5.3	50	0.1600	0.16		Sheet Flow, First 50 feet of woods Woods: Light underbrush n= 0.400 P2= 3.25"
0.6	100	0.3300	2.87		Shallow Concentrated Flow, Next 100 feet of woods Woodland Kv= 5.0 fps
0.5	55	0.1600	2.00		Shallow Concentrated Flow, Next 55 feet of woods Woodland Kv= 5.0 fps
2.3	155	0.0500	1.12		Shallow Concentrated Flow, Next 155 feet of woods Woodland Kv= 5.0 fps
0.8	100	0.1000	2.21		Shallow Concentrated Flow, Next 100 feet of grass Short Grass Pasture Kv= 7.0 fps
1.7	160	0.0500	1.57		Shallow Concentrated Flow, Next 160 feet of grass Short Grass Pasture Kv= 7.0 fps
0.3	50	0.1250	2.47		Shallow Concentrated Flow, Last 50 feet of grass Short Grass Pasture Kv= 7.0 fps
11.5	670	Total			

Summary for Subcatchment EX-1C: EX-1C

Runoff = 1.5 cfs @ 12.08 hrs, Volume= 0.114 af, Depth= 2.59"

Runoff by SCS TR-20 method, UH=SCS, Weighted-CN, Time Span= 0.00-72.00 hrs, dt= 0.01 hrs
Type III 24-hr 2-yr, 24-hr Rainfall=3.25"

Area (ac)	CN	Description
* 0.00	0	, HSG C
0.08	74	>75% Grass cover, Good, HSG C
0.40	98	Paved parking, HSG C
0.04	98	Unconnected pavement, HSG C
0.53	94	Weighted Average
0.08		15.00% Pervious Area
0.45		85.00% Impervious Area
0.04		9.78% Unconnected

Tc (min)	Length (feet)	Slope (ft/ft)	Velocity (ft/sec)	Capacity (cfs)	Description
6.0					Direct Entry,

Summary for Subcatchment EX-2: EX-2

Runoff = 2.5 cfs @ 12.09 hrs, Volume= 0.183 af, Depth= 1.13"

Runoff by SCS TR-20 method, UH=SCS, Weighted-CN, Time Span= 0.00-72.00 hrs, dt= 0.01 hrs
Type III 24-hr 2-yr, 24-hr Rainfall=3.25"

13555.04-EX

Prepared by VHB

HydroCAD® 10.10-5a s/n 01038 © 2020 HydroCAD Software Solutions LLC

Existing Conditions
Type III 24-hr 2-yr, 24-hr Rainfall=3.25"

Printed 9/23/2021

Area (ac)	CN	Description
0.56	74	>75% Grass cover, Good, HSG C
0.37	89	Gravel roads, HSG C
0.00	98	Roofs, HSG C
1.01	70	Woods, Good, HSG C
1.95	75	Weighted Average
1.94		99.89% Pervious Area
0.00		0.11% Impervious Area

Tc (min)	Length (feet)	Slope (ft/ft)	Velocity (ft/sec)	Capacity (cfs)	Description
6.0					Direct Entry, Use Minimum - Actual calculated Tc is slightly less

Summary for Subcatchment EX-3A: EX-3A

Runoff = 2.9 cfs @ 12.23 hrs, Volume= 0.292 af, Depth= 1.07"

Runoff by SCS TR-20 method, UH=SCS, Weighted-CN, Time Span= 0.00-72.00 hrs, dt= 0.01 hrs
Type III 24-hr 2-yr, 24-hr Rainfall=3.25"

Area (ac)	CN	Description
* 0.00	0	, HSG C
1.16	74	>75% Grass cover, Good, HSG C
0.31	89	Gravel roads, HSG C
0.03	98	Roofs, HSG C
0.00	98	Unconnected pavement, HSG C
1.77	70	Woods, Good, HSG C
3.28	74	Weighted Average
3.24		98.94% Pervious Area
0.03		1.06% Impervious Area
0.00		4.49% Unconnected

13555.04-EX

Prepared by VHB

HydroCAD® 10.10-5a s/n 01038 © 2020 HydroCAD Software Solutions LLC

Existing Conditions
Type III 24-hr 2-yr, 24-hr Rainfall=3.25"

Printed 9/23/2021

Tc (min)	Length (feet)	Slope (ft/ft)	Velocity (ft/sec)	Capacity (cfs)	Description
6.0	30	0.0430	0.08		Sheet Flow, First 30 feet of woods Woods: Light underbrush n= 0.400 P2= 3.25"
2.5	20	0.1700	0.13		Sheet Flow, Next 20 feet of woods Woods: Light underbrush n= 0.400 P2= 3.25"
0.2	20	0.1400	1.87		Shallow Concentrated Flow, Next 20 feet of woods Woodland Kv= 5.0 fps
0.1	10	0.1000	2.21		Shallow Concentrated Flow, Next 10 feet of grass Short Grass Pasture Kv= 7.0 fps
0.0	5	0.0250	2.55		Shallow Concentrated Flow, Next 5 feet of gravel Unpaved Kv= 16.1 fps
0.5	35	0.0250	1.11		Shallow Concentrated Flow, Next 35 feet of grass Short Grass Pasture Kv= 7.0 fps
0.4	75	0.0400	3.22		Shallow Concentrated Flow, Next 75 feet of gravel Unpaved Kv= 16.1 fps
0.2	30	0.3300	2.87		Shallow Concentrated Flow, Next 30 feet of woods Woodland Kv= 5.0 fps
1.4	145	0.1250	1.77		Shallow Concentrated Flow, Next 145 feet of woods Woodland Kv= 5.0 fps
1.7	80	0.0120	0.77		Shallow Concentrated Flow, Next 80 feet of grass Short Grass Pasture Kv= 7.0 fps
2.2	175	0.0360	1.33		Shallow Concentrated Flow, Next 175 feet of grass Short Grass Pasture Kv= 7.0 fps
0.1	15	0.2900	3.77		Shallow Concentrated Flow, Next 15 feet of grass Short Grass Pasture Kv= 7.0 fps
0.4	25	0.0500	1.12		Shallow Concentrated Flow, Last 25 feet of woods Woodland Kv= 5.0 fps
15.7	665	Total			

Summary for Subcatchment EX-3B: EX-3B

Runoff = 0.9 cfs @ 12.09 hrs, Volume= 0.063 af, Depth= 2.40"

Runoff by SCS TR-20 method, UH=SCS, Weighted-CN, Time Span= 0.00-72.00 hrs, dt= 0.01 hrs
Type III 24-hr 2-yr, 24-hr Rainfall=3.25"

Area (ac)	CN	Description
0.07	74	>75% Grass cover, Good, HSG C
0.23	98	Paved parking, HSG C
0.01	70	Woods, Good, HSG C
0.32	92	Weighted Average
0.08		26.23% Pervious Area
0.23		73.77% Impervious Area

Tc (min)	Length (feet)	Slope (ft/ft)	Velocity (ft/sec)	Capacity (cfs)	Description
6.0					Direct Entry,

13555.04-EX

Prepared by VHB

HydroCAD® 10.10-5a s/n 01038 © 2020 HydroCAD Software Solutions LLC

Existing Conditions
Type III 24-hr 2-yr, 24-hr Rainfall=3.25"

Printed 9/23/2021

Summary for Subcatchment EX-4: Subcat EX-4

Runoff = 2.0 cfs @ 12.09 hrs, Volume= 0.143 af, Depth= 1.44"

Runoff by SCS TR-20 method, UH=SCS, Weighted-CN, Time Span= 0.00-72.00 hrs, dt= 0.01 hrs
Type III 24-hr 2-yr, 24-hr Rainfall=3.25"

Area (ac)	CN	Description
0.69	74	>75% Grass cover, Good, HSG C
0.21	98	Paved parking, HSG C
0.09	98	Roofs, HSG C
0.04	98	Unconnected pavement, HSG C
0.16	70	Woods, Good, HSG C
1.19	80	Weighted Average
0.85		70.96% Pervious Area
0.35		29.04% Impervious Area
0.04		12.65% Unconnected

Tc (min)	Length (feet)	Slope (ft/ft)	Velocity (ft/sec)	Capacity (cfs)	Description
6.0					Direct Entry,

Summary for Pond 1P: EX Pond

Inflow Area = 1.23 ac, 15.48% Impervious, Inflow Depth = 1.25" for 2-yr, 24-hr event
 Inflow = 1.7 cfs @ 12.09 hrs, Volume= 0.127 af
 Outflow = 1.3 cfs @ 12.16 hrs, Volume= 0.121 af, Atten= 24%, Lag= 4.2 min
 Primary = 1.3 cfs @ 12.16 hrs, Volume= 0.121 af

Routing by Stor-Ind method, Time Span= 0.00-72.00 hrs, dt= 0.01 hrs
 Peak Elev= 179.10' @ 12.16 hrs Surf.Area= 1,017 sf Storage= 887 cf

Plug-Flow detention time= 53.1 min calculated for 0.121 af (95% of inflow)
 Center-of-Mass det. time= 27.2 min (878.7 - 851.5)

Volume	Invert	Avail.Storage	Storage Description
#1	178.00'	5,867 cf	Custom Stage Data (Prismatic) Listed below (Recalc)

Elevation (feet)	Surf.Area (sq-ft)	Inc.Store (cubic-feet)	Cum.Store (cubic-feet)
178.00	592	0	0
179.00	973	783	783
180.00	1,389	1,181	1,964
181.00	1,872	1,631	3,594
182.00	2,674	2,273	5,867

Device	Routing	Invert	Outlet Devices
#1	Primary	178.40'	12.0" Round Culvert L= 99.0' CPP, projecting, no headwall, Ke= 0.900 Inlet / Outlet Invert= 178.40' / 176.70' S= 0.0172 ' S= 0.0172 ' Cc= 0.900

13555.04-EX

Prepared by VHB

HydroCAD® 10.10-5a s/n 01038 © 2020 HydroCAD Software Solutions LLC

Existing Conditions
Type III 24-hr 2-yr, 24-hr Rainfall=3.25"

Printed 9/23/2021

#2	Primary	181.40'	n= 0.013 Corrugated PE, smooth interior, Flow Area= 0.79 sf
			28.0' long x 5.0' breadth Broad-Crested Rectangular Weir
			Head (feet) 0.20 0.40 0.60 0.80 1.00 1.20 1.40 1.60 1.80 2.00
			2.50 3.00 3.50 4.00 4.50 5.00 5.50
			Coef. (English) 2.34 2.50 2.70 2.68 2.68 2.66 2.65 2.65 2.65
			2.65 2.67 2.66 2.68 2.70 2.74 2.79 2.88

Primary OutFlow Max=1.3 cfs @ 12.16 hrs HW=179.10' (Free Discharge)

1=Culvert (Inlet Controls 1.3 cfs @ 2.26 fps)

2=Broad-Crested Rectangular Weir (Controls 0.0 cfs)

Summary for Link DP-1: Olmsted Road Drainage System

Inflow Area =	6.51 ac, 11.39% Impervious, Inflow Depth = 1.14" for 2-yr, 24-hr event
Inflow =	6.5 cfs @ 12.15 hrs, Volume= 0.616 af
Primary =	6.5 cfs @ 12.15 hrs, Volume= 0.616 af, Atten= 0%, Lag= 0.0 min

Primary outflow = Inflow, Time Span= 0.00-72.00 hrs, dt= 0.01 hrs

Summary for Link DP-2: Olmstead Road to Pleasant Street

Inflow Area =	1.95 ac, 0.11% Impervious, Inflow Depth = 1.13" for 2-yr, 24-hr event
Inflow =	2.5 cfs @ 12.09 hrs, Volume= 0.183 af
Primary =	2.5 cfs @ 12.09 hrs, Volume= 0.183 af, Atten= 0%, Lag= 0.0 min

Primary outflow = Inflow, Time Span= 0.00-72.00 hrs, dt= 0.01 hrs

Summary for Link DP-3: Intermittent Stream

Inflow Area =	3.59 ac, 7.48% Impervious, Inflow Depth = 1.19" for 2-yr, 24-hr event
Inflow =	3.3 cfs @ 12.22 hrs, Volume= 0.356 af
Primary =	3.3 cfs @ 12.22 hrs, Volume= 0.356 af, Atten= 0%, Lag= 0.0 min

Primary outflow = Inflow, Time Span= 0.00-72.00 hrs, dt= 0.01 hrs

Summary for Link DP-4: Uphams Bowl

Inflow Area =	1.19 ac, 29.04% Impervious, Inflow Depth = 1.44" for 2-yr, 24-hr event
Inflow =	2.0 cfs @ 12.09 hrs, Volume= 0.143 af
Primary =	2.0 cfs @ 12.09 hrs, Volume= 0.143 af, Atten= 0%, Lag= 0.0 min

Primary outflow = Inflow, Time Span= 0.00-72.00 hrs, dt= 0.01 hrs

13555.04-EX

Prepared by VHB

HydroCAD® 10.10-5a s/n 01038 © 2020 HydroCAD Software Solutions LLC

Existing Conditions
Type III 24-hr 10-yr, 24-hr Rainfall=5.14"

Printed 9/23/2021

Time span=0.00-72.00 hrs, dt=0.01 hrs, 7201 points
 Runoff by SCS TR-20 method, UH=SCS, Weighted-CN
 Reach routing by Stor-Ind+Trans method - Pond routing by Stor-Ind method

SubcatchmentEX-1A: EX-1A	Runoff Area=1.23 ac 15.48% Impervious Runoff Depth=2.74" Tc=6.0 min CN=77 Runoff=3.9 cfs 0.280 af
SubcatchmentEX-1B: EX-1B	Runoff Area=4.76 ac 2.21% Impervious Runoff Depth=2.31" Flow Length=670' Tc=11.5 min CN=72 Runoff=10.6 cfs 0.914 af
SubcatchmentEX-1C: EX-1C	Runoff Area=0.53 ac 85.00% Impervious Runoff Depth=4.45" Tc=6.0 min CN=94 Runoff=2.5 cfs 0.195 af
SubcatchmentEX-2: EX-2	Runoff Area=1.95 ac 0.11% Impervious Runoff Depth=2.56" Tc=6.0 min CN=75 Runoff=5.8 cfs 0.416 af
SubcatchmentEX-3A: EX-3A	Runoff Area=3.28 ac 1.06% Impervious Runoff Depth=2.48" Flow Length=665' Tc=15.7 min CN=74 Runoff=7.0 cfs 0.676 af
SubcatchmentEX-3B: EX-3B	Runoff Area=0.32 ac 73.77% Impervious Runoff Depth=4.23" Tc=6.0 min CN=92 Runoff=1.5 cfs 0.112 af
SubcatchmentEX-4: Subcat EX-4	Runoff Area=1.19 ac 29.04% Impervious Runoff Depth=3.02" Tc=6.0 min CN=80 Runoff=4.2 cfs 0.299 af
Pond 1P: EX Pond	Peak Elev=179.73' Storage=1,608 cf Inflow=3.9 cfs 0.280 af Outflow=2.7 cfs 0.274 af
Link DP-1: Olmsted Road Drainage System	Inflow=15.2 cfs 1.383 af Primary=15.2 cfs 1.383 af
Link DP-2: Olmstead Road to Pleasant Street	Inflow=5.8 cfs 0.416 af Primary=5.8 cfs 0.416 af
Link DP-3: Intermittent Stream	Inflow=7.8 cfs 0.788 af Primary=7.8 cfs 0.788 af
Link DP-4: Uphams Bowl	Inflow=4.2 cfs 0.299 af Primary=4.2 cfs 0.299 af

Total Runoff Area = 13.24 ac Runoff Volume = 2.892 af Average Runoff Depth = 2.62"
89.74% Pervious = 11.88 ac 10.26% Impervious = 1.36 ac

13555.04-EX

Prepared by VHB

HydroCAD® 10.10-5a s/n 01038 © 2020 HydroCAD Software Solutions LLC

Existing Conditions
Type III 24-hr 25-yr, 24-hr Rainfall=6.31"

Printed 9/23/2021

Time span=0.00-72.00 hrs, dt=0.01 hrs, 7201 points
 Runoff by SCS TR-20 method, UH=SCS, Weighted-CN
 Reach routing by Stor-Ind+Trans method - Pond routing by Stor-Ind method

SubcatchmentEX-1A: EX-1A Runoff Area=1.23 ac 15.48% Impervious Runoff Depth=3.75"
 Tc=6.0 min CN=77 Runoff=5.4 cfs 0.383 af

SubcatchmentEX-1B: EX-1B Runoff Area=4.76 ac 2.21% Impervious Runoff Depth=3.25"
 Flow Length=670' Tc=11.5 min CN=72 Runoff=15.1 cfs 1.288 af

SubcatchmentEX-1C: EX-1C Runoff Area=0.53 ac 85.00% Impervious Runoff Depth=5.60"
 Tc=6.0 min CN=94 Runoff=3.2 cfs 0.246 af

SubcatchmentEX-2: EX-2 Runoff Area=1.95 ac 0.11% Impervious Runoff Depth=3.55"
 Tc=6.0 min CN=75 Runoff=8.1 cfs 0.576 af

SubcatchmentEX-3A: EX-3A Runoff Area=3.28 ac 1.06% Impervious Runoff Depth=3.45"
 Flow Length=665' Tc=15.7 min CN=74 Runoff=9.8 cfs 0.941 af

SubcatchmentEX-3B: EX-3B Runoff Area=0.32 ac 73.77% Impervious Runoff Depth=5.37"
 Tc=6.0 min CN=92 Runoff=1.9 cfs 0.142 af

SubcatchmentEX-4: Subcat EX-4 Runoff Area=1.19 ac 29.04% Impervious Runoff Depth=4.06"
 Tc=6.0 min CN=80 Runoff=5.6 cfs 0.403 af

Pond 1P: EX Pond Peak Elev=180.19' Storage=2,236 cf Inflow=5.4 cfs 0.383 af
 Outflow=3.4 cfs 0.377 af

Link DP-1: Olmsted Road Drainage System Inflow=20.8 cfs 1.910 af
 Primary=20.8 cfs 1.910 af

Link DP-2: Olmstead Road to Pleasant Street Inflow=8.1 cfs 0.576 af
 Primary=8.1 cfs 0.576 af

Link DP-3: Intermittent Stream Inflow=10.8 cfs 1.083 af
 Primary=10.8 cfs 1.083 af

Link DP-4: Uphams Bowl Inflow=5.6 cfs 0.403 af
 Primary=5.6 cfs 0.403 af

Total Runoff Area = 13.24 ac Runoff Volume = 3.978 af Average Runoff Depth = 3.61"
89.74% Pervious = 11.88 ac 10.26% Impervious = 1.36 ac

13555.04-EX

Prepared by VHB

HydroCAD® 10.10-5a s/n 01038 © 2020 HydroCAD Software Solutions LLC

Existing Conditions
Type III 24-hr 100-yr, 24-hr Rainfall=8.13"

Printed 9/23/2021

Time span=0.00-72.00 hrs, dt=0.01 hrs, 7201 points
 Runoff by SCS TR-20 method, UH=SCS, Weighted-CN
 Reach routing by Stor-Ind+Trans method - Pond routing by Stor-Ind method

SubcatchmentEX-1A: EX-1A Runoff Area=1.23 ac 15.48% Impervious Runoff Depth=5.39"
 Tc=6.0 min CN=77 Runoff=7.7 cfs 0.551 af

SubcatchmentEX-1B: EX-1B Runoff Area=4.76 ac 2.21% Impervious Runoff Depth=4.81"
 Flow Length=670' Tc=11.5 min CN=72 Runoff=22.4 cfs 1.906 af

SubcatchmentEX-1C: EX-1C Runoff Area=0.53 ac 85.00% Impervious Runoff Depth=7.41"
 Tc=6.0 min CN=94 Runoff=4.1 cfs 0.325 af

SubcatchmentEX-2: EX-2 Runoff Area=1.95 ac 0.11% Impervious Runoff Depth=5.16"
 Tc=6.0 min CN=75 Runoff=11.7 cfs 0.837 af

SubcatchmentEX-3A: EX-3A Runoff Area=3.28 ac 1.06% Impervious Runoff Depth=5.04"
 Flow Length=665' Tc=15.7 min CN=74 Runoff=14.4 cfs 1.377 af

SubcatchmentEX-3B: EX-3B Runoff Area=0.32 ac 73.77% Impervious Runoff Depth=7.17"
 Tc=6.0 min CN=92 Runoff=2.5 cfs 0.190 af

SubcatchmentEX-4: Subcat EX-4 Runoff Area=1.19 ac 29.04% Impervious Runoff Depth=5.75"
 Tc=6.0 min CN=80 Runoff=7.9 cfs 0.570 af

Pond 1P: EX Pond Peak Elev=180.92' Storage=3,454 cf Inflow=7.7 cfs 0.551 af
 Outflow=4.2 cfs 0.545 af

Link DP-1: Olmsted Road Drainage System Inflow=29.6 cfs 2.775 af
 Primary=29.6 cfs 2.775 af

Link DP-2: Olmstead Road to Pleasant Street Inflow=11.7 cfs 0.837 af
 Primary=11.7 cfs 0.837 af

Link DP-3: Intermittent Stream Inflow=15.7 cfs 1.566 af
 Primary=15.7 cfs 1.566 af

Link DP-4: Uphams Bowl Inflow=7.9 cfs 0.570 af
 Primary=7.9 cfs 0.570 af

Total Runoff Area = 13.24 ac Runoff Volume = 5.755 af Average Runoff Depth = 5.22"
89.74% Pervious = 11.88 ac 10.26% Impervious = 1.36 ac

HydroCAD Analysis: Proposed Conditions

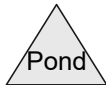
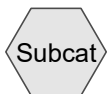
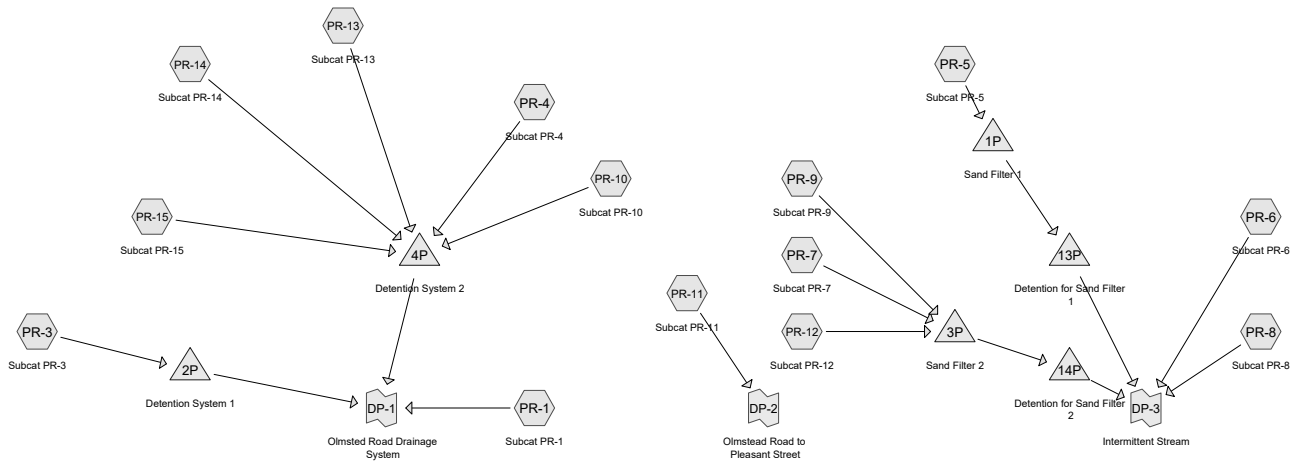
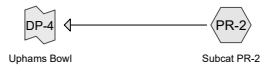

Routing Diagram for 13555.04-PR
 Prepared by VHB, Printed 9/24/2021
 HydroCAD® 10.10-5a s/n 01038 © 2020 HydroCAD Software Solutions LLC

13555.04-PR

Prepared by VHB

HydroCAD® 10.10-5a s/n 01038 © 2020 HydroCAD Software Solutions LLC

Proposed Conditions
Type III 24-hr 2-yr, 24-hr Rainfall=3.25"

Printed 9/24/2021

Time span=0.00-100.00 hrs, dt=0.01 hrs, 10001 points
 Runoff by SCS TR-20 method, UH=SCS, Weighted-CN
 Reach routing by Stor-Ind method - Pond routing by Stor-Ind method

SubcatchmentPR-1: Subcat PR-1	Runoff Area=1.483 ac 32.40% Impervious Runoff Depth=1.51" Tc=6.0 min CN=81 Runoff=2.6 cfs 0.186 af
SubcatchmentPR-10: Subcat PR-10	Runoff Area=0.268 ac 78.51% Impervious Runoff Depth=2.49" Tc=6.0 min CN=93 Runoff=0.8 cfs 0.056 af
SubcatchmentPR-11: Subcat PR-11	Runoff Area=0.479 ac 1.02% Impervious Runoff Depth=1.01" Tc=6.0 min CN=73 Runoff=0.5 cfs 0.040 af
SubcatchmentPR-12: Subcat PR-12	Runoff Area=0.161 ac 99.99% Impervious Runoff Depth=3.02" Tc=6.0 min CN=98 Runoff=0.5 cfs 0.041 af
SubcatchmentPR-13: Subcat PR-13	Runoff Area=0.242 ac 99.93% Impervious Runoff Depth=3.02" Tc=6.0 min CN=98 Runoff=0.8 cfs 0.061 af
SubcatchmentPR-14: Subcat PR-14	Runoff Area=0.242 ac 100.00% Impervious Runoff Depth=3.02" Tc=6.0 min CN=98 Runoff=0.8 cfs 0.061 af
SubcatchmentPR-15: Subcat PR-15	Runoff Area=0.091 ac 100.00% Impervious Runoff Depth=3.02" Tc=6.0 min CN=98 Runoff=0.3 cfs 0.023 af
SubcatchmentPR-2: Subcat PR-2	Runoff Area=0.519 ac 14.56% Impervious Runoff Depth=1.25" Tc=6.0 min CN=77 Runoff=0.7 cfs 0.054 af
SubcatchmentPR-3: Subcat PR-3	Runoff Area=3.321 ac 61.93% Impervious Runoff Depth=2.13" Tc=6.0 min CN=89 Runoff=8.2 cfs 0.589 af
SubcatchmentPR-4: Subcat PR-4	Runoff Area=2.110 ac 56.84% Impervious Runoff Depth=2.04" Tc=6.0 min CN=88 Runoff=5.0 cfs 0.359 af
SubcatchmentPR-5: Subcat PR-5	Runoff Area=1.800 ac 87.18% Impervious Runoff Depth=2.69" Tc=6.0 min CN=95 Runoff=5.4 cfs 0.404 af
SubcatchmentPR-6: Subcat PR-6	Runoff Area=0.451 ac 60.17% Impervious Runoff Depth=2.04" Tc=6.0 min CN=88 Runoff=1.1 cfs 0.077 af
SubcatchmentPR-7: Subcat PR-7	Runoff Area=0.846 ac 82.13% Impervious Runoff Depth=2.59" Tc=6.0 min CN=94 Runoff=2.5 cfs 0.183 af
SubcatchmentPR-8: Subcat PR-8	Runoff Area=0.966 ac 0.00% Impervious Runoff Depth=0.96" Tc=6.0 min CN=72 Runoff=1.0 cfs 0.077 af
SubcatchmentPR-9: Subcat PR-9	Runoff Area=0.261 ac 95.92% Impervious Runoff Depth=2.91" Tc=6.0 min CN=97 Runoff=0.8 cfs 0.063 af
Pond 1P: Sand Filter 1	Peak Elev=195.37' Storage=7,959 cf Inflow=5.4 cfs 0.404 af Outflow=1.8 cfs 0.404 af

13555.04-PR

Prepared by VHB

HydroCAD® 10.10-5a s/n 01038 © 2020 HydroCAD Software Solutions LLC

Proposed Conditions
Type III 24-hr 2-yr, 24-hr Rainfall=3.25"

Printed 9/24/2021

Pond 2P: Detention System 1	Peak Elev=167.83' Storage=6,278 cf Inflow=8.2 cfs 0.589 af Outflow=2.9 cfs 0.589 af
Pond 3P: Sand Filter 2	Peak Elev=174.01' Storage=6,711 cf Inflow=3.8 cfs 0.286 af Outflow=0.3 cfs 0.286 af
Pond 4P: Detention System 2	Peak Elev=148.81' Storage=7,179 cf Inflow=7.6 cfs 0.559 af Outflow=1.7 cfs 0.640 af
Pond 13P: Detention for Sand Filter 1	Peak Elev=190.56' Storage=653 cf Inflow=1.8 cfs 0.404 af Outflow=0.9 cfs 0.419 af
Pond 14P: Detention for Sand Filter 2	Peak Elev=168.38' Storage=0 cf Inflow=0.3 cfs 0.286 af Outflow=0.3 cfs 0.286 af
Link DP-1: Olmsted Road Drainage System	Inflow=6.3 cfs 1.415 af Primary=6.3 cfs 1.415 af
Link DP-2: Olmstead Road to Pleasant Street	Inflow=0.5 cfs 0.040 af Primary=0.5 cfs 0.040 af
Link DP-3: Intermittent Stream	Inflow=2.3 cfs 0.860 af Primary=2.3 cfs 0.860 af
Link DP-4: Uphams Bowl	Inflow=0.7 cfs 0.054 af Primary=0.7 cfs 0.054 af

Total Runoff Area = 13.239 ac Runoff Volume = 2.273 af Average Runoff Depth = 2.06"
42.98% Pervious = 5.691 ac 57.02% Impervious = 7.548 ac

13555.04-PR

Prepared by VHB

HydroCAD® 10.10-5a s/n 01038 © 2020 HydroCAD Software Solutions LLC

Proposed Conditions
Type III 24-hr 2-yr, 24-hr Rainfall=3.25"

Printed 9/24/2021

Summary for Subcatchment PR-1: Subcat PR-1

Runoff = 2.6 cfs @ 12.09 hrs, Volume= 0.186 af, Depth= 1.51"

Runoff by SCS TR-20 method, UH=SCS, Weighted-CN, Time Span= 0.00-100.00 hrs, dt= 0.01 hrs
Type III 24-hr 2-yr, 24-hr Rainfall=3.25"

Area (ac)	CN	Description
0.742	74	>75% Grass cover, Good, HSG C
0.480	98	Paved parking, HSG C
0.000	98	Roofs, HSG C
0.261	70	Woods, Good, HSG C
1.483	81	Weighted Average
1.002		67.60% Pervious Area
0.480		32.40% Impervious Area

Tc (min)	Length (feet)	Slope (ft/ft)	Velocity (ft/sec)	Capacity (cfs)	Description
6.0					Direct Entry,

Summary for Subcatchment PR-10: Subcat PR-10

Runoff = 0.8 cfs @ 12.09 hrs, Volume= 0.056 af, Depth= 2.49"

Runoff by SCS TR-20 method, UH=SCS, Weighted-CN, Time Span= 0.00-100.00 hrs, dt= 0.01 hrs
Type III 24-hr 2-yr, 24-hr Rainfall=3.25"

Area (ac)	CN	Description
0.058	74	>75% Grass cover, Good, HSG C
0.001	98	Paved parking, HSG C
0.209	98	Roofs, HSG C
0.268	93	Weighted Average
0.058		21.49% Pervious Area
0.210		78.51% Impervious Area

Tc (min)	Length (feet)	Slope (ft/ft)	Velocity (ft/sec)	Capacity (cfs)	Description
6.0					Direct Entry,

Summary for Subcatchment PR-11: Subcat PR-11

Runoff = 0.5 cfs @ 12.10 hrs, Volume= 0.040 af, Depth= 1.01"

Runoff by SCS TR-20 method, UH=SCS, Weighted-CN, Time Span= 0.00-100.00 hrs, dt= 0.01 hrs
Type III 24-hr 2-yr, 24-hr Rainfall=3.25"

13555.04-PR

Prepared by VHB

HydroCAD® 10.10-5a s/n 01038 © 2020 HydroCAD Software Solutions LLC

Proposed Conditions
Type III 24-hr 2-yr, 24-hr Rainfall=3.25"

Printed 9/24/2021

Area (ac)	CN	Description
0.357	74	>75% Grass cover, Good, HSG C
0.005	98	Paved parking, HSG C
0.000	98	Roofs, HSG C
0.117	70	Woods, Good, HSG C
0.479	73	Weighted Average
0.474		98.98% Pervious Area
0.005		1.02% Impervious Area

Tc (min)	Length (feet)	Slope (ft/ft)	Velocity (ft/sec)	Capacity (cfs)	Description
6.0					Direct Entry,

Summary for Subcatchment PR-12: Subcat PR-12

Runoff = 0.5 cfs @ 12.08 hrs, Volume= 0.041 af, Depth= 3.02"

Runoff by SCS TR-20 method, UH=SCS, Weighted-CN, Time Span= 0.00-100.00 hrs, dt= 0.01 hrs
Type III 24-hr 2-yr, 24-hr Rainfall=3.25"

Area (ac)	CN	Description
0.000	74	>75% Grass cover, Good, HSG C
0.001	98	Paved parking, HSG C
0.160	98	Roofs, HSG C
0.161	98	Weighted Average
0.000		0.01% Pervious Area
0.161		99.99% Impervious Area

Tc (min)	Length (feet)	Slope (ft/ft)	Velocity (ft/sec)	Capacity (cfs)	Description
6.0					Direct Entry,

Summary for Subcatchment PR-13: Subcat PR-13

Runoff = 0.8 cfs @ 12.08 hrs, Volume= 0.061 af, Depth= 3.02"

Runoff by SCS TR-20 method, UH=SCS, Weighted-CN, Time Span= 0.00-100.00 hrs, dt= 0.01 hrs
Type III 24-hr 2-yr, 24-hr Rainfall=3.25"

Area (ac)	CN	Description
0.000	74	>75% Grass cover, Good, HSG C
0.000	98	Paved parking, HSG C
0.242	98	Roofs, HSG C
0.242	98	Weighted Average
0.000		0.07% Pervious Area
0.242		99.93% Impervious Area

13555.04-PR

Prepared by VHB

HydroCAD® 10.10-5a s/n 01038 © 2020 HydroCAD Software Solutions LLC

Proposed Conditions
Type III 24-hr 2-yr, 24-hr Rainfall=3.25"

Printed 9/24/2021

Tc (min)	Length (feet)	Slope (ft/ft)	Velocity (ft/sec)	Capacity (cfs)	Description
6.0					Direct Entry,

Summary for Subcatchment PR-14: Subcat PR-14

Runoff = 0.8 cfs @ 12.08 hrs, Volume= 0.061 af, Depth= 3.02"

Runoff by SCS TR-20 method, UH=SCS, Weighted-CN, Time Span= 0.00-100.00 hrs, dt= 0.01 hrs
Type III 24-hr 2-yr, 24-hr Rainfall=3.25"

Area (ac)	CN	Description
0.000	74	>75% Grass cover, Good, HSG C
0.242	98	Roofs, HSG C
0.242	98	Weighted Average
0.000		0.00% Pervious Area
0.242		100.00% Impervious Area

Tc (min)	Length (feet)	Slope (ft/ft)	Velocity (ft/sec)	Capacity (cfs)	Description
6.0					Direct Entry,

Summary for Subcatchment PR-15: Subcat PR-15

Runoff = 0.3 cfs @ 12.08 hrs, Volume= 0.023 af, Depth= 3.02"

Runoff by SCS TR-20 method, UH=SCS, Weighted-CN, Time Span= 0.00-100.00 hrs, dt= 0.01 hrs
Type III 24-hr 2-yr, 24-hr Rainfall=3.25"

Area (ac)	CN	Description
0.000	74	>75% Grass cover, Good, HSG C
0.091	98	Roofs, HSG C
0.091	98	Weighted Average
0.000		0.00% Pervious Area
0.091		100.00% Impervious Area

Tc (min)	Length (feet)	Slope (ft/ft)	Velocity (ft/sec)	Capacity (cfs)	Description
6.0					Direct Entry,

Summary for Subcatchment PR-2: Subcat PR-2

Runoff = 0.7 cfs @ 12.09 hrs, Volume= 0.054 af, Depth= 1.25"

Runoff by SCS TR-20 method, UH=SCS, Weighted-CN, Time Span= 0.00-100.00 hrs, dt= 0.01 hrs
Type III 24-hr 2-yr, 24-hr Rainfall=3.25"

13555.04-PR

Prepared by VHB

HydroCAD® 10.10-5a s/n 01038 © 2020 HydroCAD Software Solutions LLC

Proposed Conditions
Type III 24-hr 2-yr, 24-hr Rainfall=3.25"

Printed 9/24/2021

Area (ac)	CN	Description
0.443	74	>75% Grass cover, Good, HSG C
0.049	98	Paved parking, HSG C
0.027	98	Roofs, HSG C
0.519	77	Weighted Average
0.443		85.44% Pervious Area
0.076		14.56% Impervious Area

Tc (min)	Length (feet)	Slope (ft/ft)	Velocity (ft/sec)	Capacity (cfs)	Description
6.0					Direct Entry,

Summary for Subcatchment PR-3: Subcat PR-3

Runoff = 8.2 cfs @ 12.09 hrs, Volume= 0.589 af, Depth= 2.13"

Runoff by SCS TR-20 method, UH=SCS, Weighted-CN, Time Span= 0.00-100.00 hrs, dt= 0.01 hrs
Type III 24-hr 2-yr, 24-hr Rainfall=3.25"

Area (ac)	CN	Description
1.264	74	>75% Grass cover, Good, HSG C
1.299	98	Paved parking, HSG C
0.757	98	Roofs, HSG C
3.321	89	Weighted Average
1.264		38.07% Pervious Area
2.057		61.93% Impervious Area

Tc (min)	Length (feet)	Slope (ft/ft)	Velocity (ft/sec)	Capacity (cfs)	Description
6.0					Direct Entry,

Summary for Subcatchment PR-4: Subcat PR-4

Runoff = 5.0 cfs @ 12.09 hrs, Volume= 0.359 af, Depth= 2.04"

Runoff by SCS TR-20 method, UH=SCS, Weighted-CN, Time Span= 0.00-100.00 hrs, dt= 0.01 hrs
Type III 24-hr 2-yr, 24-hr Rainfall=3.25"

Area (ac)	CN	Description
0.911	74	>75% Grass cover, Good, HSG C
0.990	98	Paved parking, HSG C
0.209	98	Roofs, HSG C
2.110	88	Weighted Average
0.911		43.16% Pervious Area
1.199		56.84% Impervious Area

13555.04-PR

Prepared by VHB

HydroCAD® 10.10-5a s/n 01038 © 2020 HydroCAD Software Solutions LLC

Proposed Conditions
Type III 24-hr 2-yr, 24-hr Rainfall=3.25"

Printed 9/24/2021

Tc (min)	Length (feet)	Slope (ft/ft)	Velocity (ft/sec)	Capacity (cfs)	Description
6.0					Direct Entry,

Summary for Subcatchment PR-5: Subcat PR-5

Runoff = 5.4 cfs @ 12.08 hrs, Volume= 0.404 af, Depth= 2.69"

Runoff by SCS TR-20 method, UH=SCS, Weighted-CN, Time Span= 0.00-100.00 hrs, dt= 0.01 hrs
Type III 24-hr 2-yr, 24-hr Rainfall=3.25"

Area (ac)	CN	Description
0.231	74	>75% Grass cover, Good, HSG C
0.740	98	Paved parking, HSG C
0.829	98	Roofs, HSG C
1.800	95	Weighted Average
0.231		12.82% Pervious Area
1.569		87.18% Impervious Area

Tc (min)	Length (feet)	Slope (ft/ft)	Velocity (ft/sec)	Capacity (cfs)	Description
6.0					Direct Entry,

Summary for Subcatchment PR-6: Subcat PR-6

Runoff = 1.1 cfs @ 12.09 hrs, Volume= 0.077 af, Depth= 2.04"

Runoff by SCS TR-20 method, UH=SCS, Weighted-CN, Time Span= 0.00-100.00 hrs, dt= 0.01 hrs
Type III 24-hr 2-yr, 24-hr Rainfall=3.25"

Area (ac)	CN	Description
0.180	74	>75% Grass cover, Good, HSG C
0.271	98	Paved parking, HSG C
0.451	88	Weighted Average
0.180		39.83% Pervious Area
0.271		60.17% Impervious Area

Tc (min)	Length (feet)	Slope (ft/ft)	Velocity (ft/sec)	Capacity (cfs)	Description
6.0					Direct Entry,

Summary for Subcatchment PR-7: Subcat PR-7

Runoff = 2.5 cfs @ 12.08 hrs, Volume= 0.183 af, Depth= 2.59"

Runoff by SCS TR-20 method, UH=SCS, Weighted-CN, Time Span= 0.00-100.00 hrs, dt= 0.01 hrs
Type III 24-hr 2-yr, 24-hr Rainfall=3.25"

13555.04-PR

Prepared by VHB

HydroCAD® 10.10-5a s/n 01038 © 2020 HydroCAD Software Solutions LLC

Proposed Conditions
Type III 24-hr 2-yr, 24-hr Rainfall=3.25"

Printed 9/24/2021

Area (ac)	CN	Description
0.151	74	>75% Grass cover, Good, HSG C
0.461	98	Paved parking, HSG C
0.234	98	Roofs, HSG C
0.846	94	Weighted Average
0.151		17.87% Pervious Area
0.695		82.13% Impervious Area

Tc (min)	Length (feet)	Slope (ft/ft)	Velocity (ft/sec)	Capacity (cfs)	Description
6.0					Direct Entry,

Summary for Subcatchment PR-8: Subcat PR-8

Runoff = 1.0 cfs @ 12.10 hrs, Volume= 0.077 af, Depth= 0.96"

Runoff by SCS TR-20 method, UH=SCS, Weighted-CN, Time Span= 0.00-100.00 hrs, dt= 0.01 hrs
Type III 24-hr 2-yr, 24-hr Rainfall=3.25"

Area (ac)	CN	Description
0.465	74	>75% Grass cover, Good, HSG C
0.000	98	Paved parking, HSG C
0.000	98	Roofs, HSG C
0.501	70	Woods, Good, HSG C
0.966	72	Weighted Average
0.966		100.00% Pervious Area
0.000		0.00% Impervious Area

Tc (min)	Length (feet)	Slope (ft/ft)	Velocity (ft/sec)	Capacity (cfs)	Description
6.0					Direct Entry,

Summary for Subcatchment PR-9: Subcat PR-9

Runoff = 0.8 cfs @ 12.08 hrs, Volume= 0.063 af, Depth= 2.91"

Runoff by SCS TR-20 method, UH=SCS, Weighted-CN, Time Span= 0.00-100.00 hrs, dt= 0.01 hrs
Type III 24-hr 2-yr, 24-hr Rainfall=3.25"

Area (ac)	CN	Description
0.011	74	>75% Grass cover, Good, HSG C
0.001	98	Paved parking, HSG C
0.249	98	Roofs, HSG C
0.261	97	Weighted Average
0.011		4.08% Pervious Area
0.250		95.92% Impervious Area

13555.04-PR

Prepared by VHB

HydroCAD® 10.10-5a s/n 01038 © 2020 HydroCAD Software Solutions LLC

Proposed Conditions
Type III 24-hr 2-yr, 24-hr Rainfall=3.25"

Printed 9/24/2021

Tc (min)	Length (feet)	Slope (ft/ft)	Velocity (ft/sec)	Capacity (cfs)	Description
6.0					Direct Entry,

Summary for Pond 1P: Sand Filter 1

Inflow Area = 1.800 ac, 87.18% Impervious, Inflow Depth = 2.69" for 2-yr, 24-hr event
 Inflow = 5.4 cfs @ 12.08 hrs, Volume= 0.404 af
 Outflow = 1.8 cfs @ 12.36 hrs, Volume= 0.404 af, Atten= 66%, Lag= 16.8 min
 Primary = 1.8 cfs @ 12.36 hrs, Volume= 0.404 af

Routing by Stor-Ind method, Time Span= 0.00-100.00 hrs, dt= 0.01 hrs
 Peak Elev= 195.37' @ 12.36 hrs Surf.Area= 2,422 sf Storage= 7,959 cf

Plug-Flow detention time= 520.7 min calculated for 0.404 af (100% of inflow)
 Center-of-Mass det. time= 520.8 min (1,301.3 - 780.5)

Volume	Invert	Avail.Storage	Storage Description
#1	189.50'	10,074 cf	30.27'W x 80.00'L x 8.00'H Stormtrap Footprint 19,373 cf Overall - 7,265 cf Embedded = 12,108 cf x 83.2% Voids
#2	189.50'	2,179 cf	30.27'W x 80.00'L x 3.00'H Sand Filter Inside #1 7,265 cf Overall x 30.0% Voids
		12,253 cf	Total Available Storage

Device	Routing	Invert	Outlet Devices
#1	Primary	189.50'	6.0" Vert. Orifice/Grate X 5.00 C= 0.600 Limited to weir flow at low heads
#2	Device 1	189.50'	2.000 in/hr Exfiltration over Surface area Phase-In= 0.01'
#3	Primary	195.30'	30.3' long x 0.5' breadth Broad-Crested Rectangular Weir Head (feet) 0.20 0.40 0.60 0.80 1.00 Coef. (English) 2.80 2.92 3.08 3.30 3.32

Primary OutFlow Max=1.6 cfs @ 12.36 hrs HW=195.37' (Free Discharge)

1=Orifice/Grate (Passes 0.1 cfs of 11.2 cfs potential flow)
 2=Exfiltration (Exfiltration Controls 0.1 cfs)
 3=Broad-Crested Rectangular Weir (Weir Controls 1.5 cfs @ 0.73 fps)

Summary for Pond 2P: Detention System 1

Inflow Area = 3.321 ac, 61.93% Impervious, Inflow Depth = 2.13" for 2-yr, 24-hr event
 Inflow = 8.2 cfs @ 12.09 hrs, Volume= 0.589 af
 Outflow = 2.9 cfs @ 12.37 hrs, Volume= 0.589 af, Atten= 65%, Lag= 16.8 min
 Primary = 2.9 cfs @ 12.37 hrs, Volume= 0.589 af

Routing by Stor-Ind method, Time Span= 0.00-100.00 hrs, dt= 0.01 hrs / 2
 Peak Elev= 167.83' @ 12.37 hrs Surf.Area= 2,083 sf Storage= 6,278 cf

Plug-Flow detention time= 33.1 min calculated for 0.589 af (100% of inflow)
 Center-of-Mass det. time= 33.1 min (843.6 - 810.5)

13555.04-PR

Prepared by VHB

HydroCAD® 10.10-5a s/n 01038 © 2020 HydroCAD Software Solutions LLC

Proposed Conditions
Type III 24-hr 2-yr, 24-hr Rainfall=3.25"

Printed 9/24/2021

Volume	Invert	Avail.Storage	Storage Description
#1A	164.00'	0 cf	47.23'W x 44.10'L x 11.00'H Field A 22,913 cf Overall - 22,913 cf Embedded = 0 cf x 40.0% Voids
#2A	164.00'	18,861 cf	StormTrap ST2 DoubleTrap 10-0x 8 Inside #1 Inside= 101.7"W x 120.0"H => 78.88 sf x 15.40'L = 1,214.5 cf Outside= 101.7"W x 132.0"H => 93.27 sf x 15.40'L = 1,436.0 cf 8 Chambers in 4 Rows 33.92' x 30.79' Core + 6.66' Border = 47.23' x 44.10' System
		18,861 cf	Total Available Storage

Storage Group A created with Chamber Wizard

Device	Routing	Invert	Outlet Devices
#1	Primary	164.50'	12.0" Vert. Orifice/Grate C= 0.600 Limited to weir flow at low heads
#2	Device 1	167.90'	10.0" Vert. Orifice/Grate C= 0.600 Limited to weir flow at low heads
#3	Device 1	170.10'	10.0" Vert. Orifice/Grate C= 0.600 Limited to weir flow at low heads
#4	Device 1	171.40'	12.0" Vert. Orifice/Grate C= 0.600 Limited to weir flow at low heads
#5	Device 1	164.50'	8.0" Vert. Orifice/Grate C= 0.600 Limited to weir flow at low heads

Primary OutFlow Max=2.9 cfs @ 12.37 hrs HW=167.83' (Free Discharge)

- 1=Orifice/Grate (Passes 2.9 cfs of 6.4 cfs potential flow)
- 2=Orifice/Grate (Controls 0.0 cfs)
- 3=Orifice/Grate (Controls 0.0 cfs)
- 4=Orifice/Grate (Controls 0.0 cfs)
- 5=Orifice/Grate (Orifice Controls 2.9 cfs @ 8.33 fps)

Summary for Pond 3P: Sand Filter 2

Inflow Area = 1.268 ac, 87.23% Impervious, Inflow Depth = 2.71" for 2-yr, 24-hr event
 Inflow = 3.8 cfs @ 12.08 hrs, Volume= 0.286 af
 Outflow = 0.3 cfs @ 12.99 hrs, Volume= 0.286 af, Atten= 91%, Lag= 54.3 min
 Primary = 0.3 cfs @ 12.99 hrs, Volume= 0.286 af

Routing by Stor-Ind method, Time Span= 0.00-100.00 hrs, dt= 0.01 hrs
 Peak Elev= 174.01' @ 12.99 hrs Surf.Area= 1,970 sf Storage= 6,711 cf

Plug-Flow detention time= 618.2 min calculated for 0.286 af (100% of inflow)
 Center-of-Mass det. time= 618.3 min (1,396.0 - 777.7)

Volume	Invert	Avail.Storage	Storage Description
#1	168.00'	8,193 cf	30.30'W x 65.00'L x 8.00'H Stormtrap Footprint 15,756 cf Overall - 5,909 cf Embedded = 9,848 cf x 83.2% Voids
#2	168.00'	1,773 cf	30.30'W x 65.00'L x 3.00'H Sand Filter Inside #1 5,909 cf Overall x 30.0% Voids
		9,966 cf	Total Available Storage

Device	Routing	Invert	Outlet Devices
#1	Primary	168.00'	6.0" Vert. Orifice/Grate X 2.00 C= 0.600 Limited to weir flow at low heads
#2	Primary	174.00'	21.8' long x 0.5' breadth Broad-Crested Rectangular Weir

13555.04-PR

Prepared by VHB

HydroCAD® 10.10-5a s/n 01038 © 2020 HydroCAD Software Solutions LLC

Proposed Conditions
 Type III 24-hr 2-yr, 24-hr Rainfall=3.25"

Printed 9/24/2021

			Head (feet)	0.20	0.40	0.60	0.80	1.00	
			Coef. (English)	2.80	2.92	3.08	3.30	3.32	
#3	Device 1	168.00'	2.000 in/hr Exfiltration over Surface area	Phase-In= 0.10'					

Primary OutFlow Max=0.2 cfs @ 12.99 hrs HW=174.01' (Free Discharge)

- 1=Orifice/Grate (Passes 0.1 cfs of 4.5 cfs potential flow)
- 3=Exfiltration (Exfiltration Controls 0.1 cfs)
- 2=Broad-Crested Rectangular Weir (Weir Controls 0.1 cfs @ 0.33 fps)

Summary for Pond 4P: Detention System 2

Inflow Area =	2.953 ac, 67.21% Impervious, Inflow Depth = 2.27" for 2-yr, 24-hr event
Inflow =	7.6 cfs @ 12.09 hrs, Volume= 0.559 af
Outflow =	1.7 cfs @ 12.51 hrs, Volume= 0.640 af, Atten= 78%, Lag= 25.1 min
Primary =	1.7 cfs @ 12.51 hrs, Volume= 0.640 af

Routing by Stor-Ind method, Time Span= 0.00-100.00 hrs, dt= 0.01 hrs / 2
 Peak Elev= 148.81' @ 12.51 hrs Surf.Area= 2,810 sf Storage= 7,179 cf

Plug-Flow detention time= (not calculated: outflow precedes inflow)
 Center-of-Mass det. time= 76.6 min (873.7 - 797.1)

Volume	Invert	Avail.Storage	Storage Description
#1A	145.50'	0 cf	47.23'W x 59.50'L x 11.00'H Field A 30,911 cf Overall - 30,911 cf Embedded = 0 cf x 40.0% Voids
#2A	145.50'	25,524 cf	StormTrap ST2 DoubleTrap 10-0x 12 Inside #1 Inside= 101.7"W x 120.0"H => 78.88 sf x 15.40'L = 1,214.5 cf Outside= 101.7"W x 132.0"H => 93.27 sf x 15.40'L = 1,436.0 cf 12 Chambers in 4 Rows 33.92' x 46.19' Core + 6.66' Border = 47.23' x 59.50' System
		25,524 cf	Total Available Storage

Storage Group A created with Chamber Wizard

Device	Routing	Invert	Outlet Devices
#1	Primary	145.51'	8.0" Vert. Orifice/Grate C= 0.600 Limited to weir flow at low heads
#2	Device 1	152.00'	4.0' long x 0.5' breadth Broad-Crested Rectangular Weir Head (feet) 0.20 0.40 0.60 0.80 1.00 Coef. (English) 2.80 2.92 3.08 3.30 3.32
#3	Device 1	145.51'	6.0" Vert. Orifice/Grate C= 0.600 Limited to weir flow at low heads

Primary OutFlow Max=1.7 cfs @ 12.51 hrs HW=148.81' (Free Discharge)

- 1=Orifice/Grate (Passes 1.7 cfs of 2.9 cfs potential flow)
- 2=Broad-Crested Rectangular Weir (Controls 0.0 cfs)
- 3=Orifice/Grate (Orifice Controls 1.7 cfs @ 8.41 fps)

13555.04-PR

Prepared by VHB

HydroCAD® 10.10-5a s/n 01038 © 2020 HydroCAD Software Solutions LLC

Proposed Conditions
Type III 24-hr 2-yr, 24-hr Rainfall=3.25"

Printed 9/24/2021

Summary for Pond 13P: Detention for Sand Filter 1

Inflow Area = 1.800 ac, 87.18% Impervious, Inflow Depth = 2.69" for 2-yr, 24-hr event
 Inflow = 1.8 cfs @ 12.36 hrs, Volume= 0.404 af
 Outflow = 0.9 cfs @ 12.56 hrs, Volume= 0.419 af, Atten= 49%, Lag= 11.8 min
 Primary = 0.9 cfs @ 12.56 hrs, Volume= 0.419 af

Routing by Stor-Ind method, Time Span= 0.00-100.00 hrs, dt= 0.01 hrs / 2
 Peak Elev= 190.56' @ 12.56 hrs Surf.Area= 1,335 sf Storage= 653 cf

Plug-Flow detention time= (not calculated: outflow precedes inflow)
 Center-of-Mass det. time= 16.7 min (1,318.0 - 1,301.3)

Volume	Invert	Avail.Storage	Storage Description
#1A	189.50'	0 cf	30.27'W x 44.10'L x 9.00'H Field A 12,016 cf Overall - 12,016 cf Embedded = 0 cf x 40.0% Voids
#2A	189.50'	9,385 cf	StormTrap ST2 DoubleTrap 8-0x 4 Inside #1 Inside= 101.7"W x 96.0"H => 61.09 sf x 15.40'L = 940.5 cf Outside= 101.7"W x 108.0"H => 76.31 sf x 15.40'L = 1,174.9 cf 4 Chambers in 2 Rows 16.96' x 30.79' Core + 6.66' Border = 30.27' x 44.10' System
#3	195.60'	3,828 cf	30.27'W x 80.00'L x 1.90'H Prismatic 4,601 cf Overall x 83.2% Voids
		13,213 cf	Total Available Storage

Storage Group A created with Chamber Wizard

Device	Routing	Invert	Outlet Devices
#1	Device 4	189.50'	4.0" Vert. Orifice/Grate C= 0.600 Limited to weir flow at low heads
#2	Device 4	190.00'	6.0" Vert. Orifice/Grate C= 0.600 Limited to weir flow at low heads
#3	Device 4	194.00'	6.0" Vert. Orifice/Grate X 0.00 C= 0.600 Limited to weir flow at low heads
#4	Primary	189.50'	15.0" Vert. Orifice/Grate C= 0.600 Limited to weir flow at low heads

Primary OutFlow Max=0.9 cfs @ 12.56 hrs HW=190.56' (Free Discharge)

↑ **4=Orifice/Grate** (Passes 0.9 cfs of 3.9 cfs potential flow)
 ↑ **1=Orifice/Grate** (Orifice Controls 0.4 cfs @ 4.54 fps)
 ↑ **2=Orifice/Grate** (Orifice Controls 0.5 cfs @ 2.66 fps)
 ↑ **3=Orifice/Grate** (Controls 0.0 cfs)

Summary for Pond 14P: Detention for Sand Filter 2

Inflow Area = 1.268 ac, 87.23% Impervious, Inflow Depth = 2.71" for 2-yr, 24-hr event
 Inflow = 0.3 cfs @ 12.99 hrs, Volume= 0.286 af
 Outflow = 0.3 cfs @ 12.99 hrs, Volume= 0.286 af, Atten= 0%, Lag= 0.0 min
 Primary = 0.3 cfs @ 12.99 hrs, Volume= 0.286 af

Routing by Stor-Ind method, Time Span= 0.00-100.00 hrs, dt= 0.01 hrs / 2

13555.04-PR

Prepared by VHB

HydroCAD® 10.10-5a s/n 01038 © 2020 HydroCAD Software Solutions LLC

Proposed Conditions
Type III 24-hr 2-yr, 24-hr Rainfall=3.25"

Printed 9/24/2021

Peak Elev= 168.38' @ 12.99 hrs Surf.Area= 961 sf Storage= 0 cf

Plug-Flow detention time= (not calculated: outflow precedes inflow)

Center-of-Mass det. time= 0.0 min (1,396.0 - 1,396.0)

Volume	Invert	Avail.Storage	Storage Description
#1A	168.00'	0 cf	21.79'W x 44.10'L x 9.00'H Field A 8,650 cf Overall - 8,650 cf Embedded = 0 cf x 40.0% Voids
#2A	168.00'	6,723 cf	StormTrap ST2 DoubleTrap 8-0x 2 Inside #1 Inside= 101.7"W x 96.0"H => 61.09 sf x 15.40'L = 940.5 cf Outside= 101.7"W x 108.0"H => 76.31 sf x 15.40'L = 1,174.9 cf 8.48' x 30.79' Core + 6.66' Border = 21.79' x 44.10' System
#3	174.30'	7,694 cf	30.27'W x 65.00'L x 4.70'H Prismaoid 9,247 cf Overall x 83.2% Voids
		14,417 cf	Total Available Storage

Storage Group A created with Chamber Wizard

Device	Routing	Invert	Outlet Devices
#1	Device 5	168.00'	6.0" Vert. Orifice/Grate C= 0.600 Limited to weir flow at low heads
#2	Device 5	168.50'	6.0" Vert. Orifice/Grate X 0.00 C= 0.600 Limited to weir flow at low heads
#3	Device 5	171.00'	4.0" Vert. Orifice/Grate X 0.00 C= 0.600 Limited to weir flow at low heads
#4	Device 5	177.00'	4.0' long x 0.5' breadth Broad-Crested Rectangular Weir Head (feet) 0.20 0.40 0.60 0.80 1.00 Coef. (English) 2.80 2.92 3.08 3.30 3.32
#5	Primary	168.00'	15.0" Vert. Orifice/Grate C= 0.600 Limited to weir flow at low heads

Primary OutFlow Max=0.3 cfs @ 12.99 hrs HW=168.38' (Free Discharge)

- ↑ 5=Orifice/Grate (Passes 0.3 cfs of 0.7 cfs potential flow)
- ↑ 1=Orifice/Grate (Orifice Controls 0.3 cfs @ 2.09 fps)
- 2=Orifice/Grate (Controls 0.0 cfs)
- 3=Orifice/Grate (Controls 0.0 cfs)
- 4=Broad-Crested Rectangular Weir(Controls 0.0 cfs)

Summary for Link DP-1: Olmsted Road Drainage System

Inflow Area = 7.756 ac, 58.29% Impervious, Inflow Depth = 2.19" for 2-yr, 24-hr event
 Inflow = 6.3 cfs @ 12.12 hrs, Volume= 1.415 af
 Primary = 6.3 cfs @ 12.12 hrs, Volume= 1.415 af, Atten= 0%, Lag= 0.0 min

Primary outflow = Inflow, Time Span= 0.00-100.00 hrs, dt= 0.01 hrs

13555.04-PR

Prepared by VHB

HydroCAD® 10.10-5a s/n 01038 © 2020 HydroCAD Software Solutions LLC

Proposed Conditions

Type III 24-hr 2-yr, 24-hr Rainfall=3.25"

Printed 9/24/2021

Summary for Link DP-2: Olmstead Road to Pleasant Street

Inflow Area = 0.479 ac, 1.02% Impervious, Inflow Depth = 1.01" for 2-yr, 24-hr event
Inflow = 0.5 cfs @ 12.10 hrs, Volume= 0.040 af
Primary = 0.5 cfs @ 12.10 hrs, Volume= 0.040 af, Atten= 0%, Lag= 0.0 min

Primary outflow = Inflow, Time Span= 0.00-100.00 hrs, dt= 0.01 hrs

Summary for Link DP-3: Intermittent Stream

Inflow Area = 4.485 ac, 65.69% Impervious, Inflow Depth = 2.30" for 2-yr, 24-hr event
Inflow = 2.3 cfs @ 12.09 hrs, Volume= 0.860 af
Primary = 2.3 cfs @ 12.09 hrs, Volume= 0.860 af, Atten= 0%, Lag= 0.0 min

Primary outflow = Inflow, Time Span= 0.00-100.00 hrs, dt= 0.01 hrs

Summary for Link DP-4: Uphams Bowl

Inflow Area = 0.519 ac, 14.56% Impervious, Inflow Depth = 1.25" for 2-yr, 24-hr event
Inflow = 0.7 cfs @ 12.09 hrs, Volume= 0.054 af
Primary = 0.7 cfs @ 12.09 hrs, Volume= 0.054 af, Atten= 0%, Lag= 0.0 min

Primary outflow = Inflow, Time Span= 0.00-100.00 hrs, dt= 0.01 hrs

13555.04-PR

Prepared by VHB

HydroCAD® 10.10-5a s/n 01038 © 2020 HydroCAD Software Solutions LLC

Proposed Conditions
Type III 24-hr 10-yr, 24-hr Rainfall=5.14"

Printed 9/24/2021

Time span=0.00-100.00 hrs, dt=0.01 hrs, 10001 points
 Runoff by SCS TR-20 method, UH=SCS, Weighted-CN
 Reach routing by Stor-Ind method - Pond routing by Stor-Ind method

SubcatchmentPR-1: Subcat PR-1	Runoff Area=1.483 ac 32.40% Impervious Runoff Depth=3.11" Tc=6.0 min CN=81 Runoff=5.4 cfs 0.384 af
SubcatchmentPR-10: Subcat PR-10	Runoff Area=0.268 ac 78.51% Impervious Runoff Depth=4.34" Tc=6.0 min CN=93 Runoff=1.3 cfs 0.097 af
SubcatchmentPR-11: Subcat PR-11	Runoff Area=0.479 ac 1.02% Impervious Runoff Depth=2.39" Tc=6.0 min CN=73 Runoff=1.3 cfs 0.095 af
SubcatchmentPR-12: Subcat PR-12	Runoff Area=0.161 ac 99.99% Impervious Runoff Depth=4.90" Tc=6.0 min CN=98 Runoff=0.8 cfs 0.066 af
SubcatchmentPR-13: Subcat PR-13	Runoff Area=0.242 ac 99.93% Impervious Runoff Depth=4.90" Tc=6.0 min CN=98 Runoff=1.2 cfs 0.099 af
SubcatchmentPR-14: Subcat PR-14	Runoff Area=0.242 ac 100.00% Impervious Runoff Depth=4.90" Tc=6.0 min CN=98 Runoff=1.2 cfs 0.099 af
SubcatchmentPR-15: Subcat PR-15	Runoff Area=0.091 ac 100.00% Impervious Runoff Depth=4.90" Tc=6.0 min CN=98 Runoff=0.5 cfs 0.037 af
SubcatchmentPR-2: Subcat PR-2	Runoff Area=0.519 ac 14.56% Impervious Runoff Depth=2.74" Tc=6.0 min CN=77 Runoff=1.7 cfs 0.119 af
SubcatchmentPR-3: Subcat PR-3	Runoff Area=3.321 ac 61.93% Impervious Runoff Depth=3.91" Tc=6.0 min CN=89 Runoff=14.7 cfs 1.081 af
SubcatchmentPR-4: Subcat PR-4	Runoff Area=2.110 ac 56.84% Impervious Runoff Depth=3.80" Tc=6.0 min CN=88 Runoff=9.2 cfs 0.668 af
SubcatchmentPR-5: Subcat PR-5	Runoff Area=1.800 ac 87.18% Impervious Runoff Depth=4.56" Tc=6.0 min CN=95 Runoff=8.8 cfs 0.684 af
SubcatchmentPR-6: Subcat PR-6	Runoff Area=0.451 ac 60.17% Impervious Runoff Depth=3.80" Tc=6.0 min CN=88 Runoff=2.0 cfs 0.143 af
SubcatchmentPR-7: Subcat PR-7	Runoff Area=0.846 ac 82.13% Impervious Runoff Depth=4.45" Tc=6.0 min CN=94 Runoff=4.1 cfs 0.313 af
SubcatchmentPR-8: Subcat PR-8	Runoff Area=0.966 ac 0.00% Impervious Runoff Depth=2.31" Tc=6.0 min CN=72 Runoff=2.6 cfs 0.186 af
SubcatchmentPR-9: Subcat PR-9	Runoff Area=0.261 ac 95.92% Impervious Runoff Depth=4.79" Tc=6.0 min CN=97 Runoff=1.3 cfs 0.104 af
Pond 1P: Sand Filter 1	Peak Elev=195.52' Storage=8,257 cf Inflow=8.8 cfs 0.684 af Outflow=8.8 cfs 0.684 af

13555.04-PR

Prepared by VHB

HydroCAD® 10.10-5a s/n 01038 © 2020 HydroCAD Software Solutions LLC

Proposed Conditions
Type III 24-hr 10-yr, 24-hr Rainfall=5.14"

Printed 9/24/2021

Pond 2P: Detention System 1	Peak Elev=169.97'	Storage=10,320 cf	Inflow=14.7 cfs	1.081 af	Outflow=7.2 cfs	1.081 af
Pond 3P: Sand Filter 2	Peak Elev=174.20'	Storage=7,023 cf	Inflow=6.2 cfs	0.483 af	Outflow=5.8 cfs	0.483 af
Pond 4P: Detention System 2	Peak Elev=151.83'	Storage=14,881 cf	Inflow=13.3 cfs	1.000 af	Outflow=2.3 cfs	0.981 af
Pond 13P: Detention for Sand Filter 1	Peak Elev=193.98'	Storage=4,669 cf	Inflow=8.8 cfs	0.684 af	Outflow=2.7 cfs	0.675 af
Pond 14P: Detention for Sand Filter 2	Peak Elev=171.41'	Storage=2,444 cf	Inflow=5.8 cfs	0.483 af	Outflow=1.7 cfs	0.254 af
Link DP-1: Olmsted Road Drainage System			Inflow=13.1 cfs	2.447 af	Primary=13.1 cfs	2.447 af
Link DP-2: Olmstead Road to Pleasant Street			Inflow=1.3 cfs	0.095 af	Primary=1.3 cfs	0.095 af
Link DP-3: Intermittent Stream			Inflow=7.2 cfs	1.257 af	Primary=7.2 cfs	1.257 af
Link DP-4: Uphams Bowl			Inflow=1.7 cfs	0.119 af	Primary=1.7 cfs	0.119 af

Total Runoff Area = 13.239 ac Runoff Volume = 4.175 af Average Runoff Depth = 3.78"
42.98% Pervious = 5.691 ac 57.02% Impervious = 7.548 ac

13555.04-PR

Prepared by VHB

HydroCAD® 10.10-5a s/n 01038 © 2020 HydroCAD Software Solutions LLC

Proposed Conditions
Type III 24-hr 25-yr, 24-hr Rainfall=6.31"

Printed 9/24/2021

Time span=0.00-100.00 hrs, dt=0.01 hrs, 10001 points
 Runoff by SCS TR-20 method, UH=SCS, Weighted-CN
 Reach routing by Stor-Ind method - Pond routing by Stor-Ind method

SubcatchmentPR-1: Subcat PR-1	Runoff Area=1.483 ac 32.40% Impervious Runoff Depth=4.17" Tc=6.0 min CN=81 Runoff=7.2 cfs 0.515 af
SubcatchmentPR-10: Subcat PR-10	Runoff Area=0.268 ac 78.51% Impervious Runoff Depth=5.49" Tc=6.0 min CN=93 Runoff=1.6 cfs 0.122 af
SubcatchmentPR-11: Subcat PR-11	Runoff Area=0.479 ac 1.02% Impervious Runoff Depth=3.35" Tc=6.0 min CN=73 Runoff=1.9 cfs 0.134 af
SubcatchmentPR-12: Subcat PR-12	Runoff Area=0.161 ac 99.99% Impervious Runoff Depth=6.07" Tc=6.0 min CN=98 Runoff=1.0 cfs 0.082 af
SubcatchmentPR-13: Subcat PR-13	Runoff Area=0.242 ac 99.93% Impervious Runoff Depth=6.07" Tc=6.0 min CN=98 Runoff=1.5 cfs 0.123 af
SubcatchmentPR-14: Subcat PR-14	Runoff Area=0.242 ac 100.00% Impervious Runoff Depth=6.07" Tc=6.0 min CN=98 Runoff=1.5 cfs 0.122 af
SubcatchmentPR-15: Subcat PR-15	Runoff Area=0.091 ac 100.00% Impervious Runoff Depth=6.07" Tc=6.0 min CN=98 Runoff=0.6 cfs 0.046 af
SubcatchmentPR-2: Subcat PR-2	Runoff Area=0.519 ac 14.56% Impervious Runoff Depth=3.75" Tc=6.0 min CN=77 Runoff=2.3 cfs 0.162 af
SubcatchmentPR-3: Subcat PR-3	Runoff Area=3.321 ac 61.93% Impervious Runoff Depth=5.04" Tc=6.0 min CN=89 Runoff=18.8 cfs 1.394 af
SubcatchmentPR-4: Subcat PR-4	Runoff Area=2.110 ac 56.84% Impervious Runoff Depth=4.92" Tc=6.0 min CN=88 Runoff=11.7 cfs 0.866 af
SubcatchmentPR-5: Subcat PR-5	Runoff Area=1.800 ac 87.18% Impervious Runoff Depth=5.72" Tc=6.0 min CN=95 Runoff=10.9 cfs 0.858 af
SubcatchmentPR-6: Subcat PR-6	Runoff Area=0.451 ac 60.17% Impervious Runoff Depth=4.92" Tc=6.0 min CN=88 Runoff=2.5 cfs 0.185 af
SubcatchmentPR-7: Subcat PR-7	Runoff Area=0.846 ac 82.13% Impervious Runoff Depth=5.60" Tc=6.0 min CN=94 Runoff=5.1 cfs 0.395 af
SubcatchmentPR-8: Subcat PR-8	Runoff Area=0.966 ac 0.00% Impervious Runoff Depth=3.25" Tc=6.0 min CN=72 Runoff=3.7 cfs 0.262 af
SubcatchmentPR-9: Subcat PR-9	Runoff Area=0.261 ac 95.92% Impervious Runoff Depth=5.95" Tc=6.0 min CN=97 Runoff=1.6 cfs 0.129 af
Pond 1P: Sand Filter 1	Peak Elev=195.55' Storage=8,322 cf Inflow=10.9 cfs 0.858 af Outflow=10.9 cfs 0.858 af

13555.04-PR

Prepared by VHB

HydroCAD® 10.10-5a s/n 01038 © 2020 HydroCAD Software Solutions LLC

Proposed Conditions
Type III 24-hr 25-yr, 24-hr Rainfall=6.31"

Printed 9/24/2021

Pond 2P: Detention System 1	Peak Elev=171.31'	Storage=12,835 cf	Inflow=18.8 cfs	1.394 af
			Outflow=9.5 cfs	1.394 af
Pond 3P: Sand Filter 2	Peak Elev=174.25'	Storage=7,092 cf	Inflow=7.7 cfs	0.606 af
			Outflow=7.6 cfs	0.606 af
Pond 4P: Detention System 2	Peak Elev=153.03'	Storage=17,950 cf	Inflow=16.9 cfs	1.279 af
			Outflow=4.5 cfs	1.281 af
Pond 13P: Detention for Sand Filter 1	Peak Elev=195.90'	Storage=7,525 cf	Inflow=10.9 cfs	0.858 af
			Outflow=3.3 cfs	0.800 af
Pond 14P: Detention for Sand Filter 2	Peak Elev=173.87'	Storage=4,513 cf	Inflow=7.6 cfs	0.606 af
			Outflow=2.2 cfs	0.511 af
Link DP-1: Olmsted Road Drainage System			Inflow=17.8 cfs	3.190 af
			Primary=17.8 cfs	3.190 af
Link DP-2: Olmstead Road to Pleasant Street			Inflow=1.9 cfs	0.134 af
			Primary=1.9 cfs	0.134 af
Link DP-3: Intermittent Stream			Inflow=10.4 cfs	1.758 af
			Primary=10.4 cfs	1.758 af
Link DP-4: Uphams Bowl			Inflow=2.3 cfs	0.162 af
			Primary=2.3 cfs	0.162 af

Total Runoff Area = 13.239 ac Runoff Volume = 5.394 af Average Runoff Depth = 4.89"
42.98% Pervious = 5.691 ac 57.02% Impervious = 7.548 ac

13555.04-PR

Prepared by VHB

HydroCAD® 10.10-5a s/n 01038 © 2020 HydroCAD Software Solutions LLC

Proposed Conditions
Type III 24-hr 100-yr, 24-hr Rainfall=8.13"

Printed 9/24/2021

Time span=0.00-100.00 hrs, dt=0.01 hrs, 10001 points
 Runoff by SCS TR-20 method, UH=SCS, Weighted-CN
 Reach routing by Stor-Ind method - Pond routing by Stor-Ind method

SubcatchmentPR-1: Subcat PR-1	Runoff Area=1.483 ac 32.40% Impervious Runoff Depth=5.87" Tc=6.0 min CN=81 Runoff=10.0 cfs 0.725 af
SubcatchmentPR-10: Subcat PR-10	Runoff Area=0.268 ac 78.51% Impervious Runoff Depth=7.29" Tc=6.0 min CN=93 Runoff=2.1 cfs 0.163 af
SubcatchmentPR-11: Subcat PR-11	Runoff Area=0.479 ac 1.02% Impervious Runoff Depth=4.93" Tc=6.0 min CN=73 Runoff=2.8 cfs 0.196 af
SubcatchmentPR-12: Subcat PR-12	Runoff Area=0.161 ac 99.99% Impervious Runoff Depth=7.89" Tc=6.0 min CN=98 Runoff=1.3 cfs 0.106 af
SubcatchmentPR-13: Subcat PR-13	Runoff Area=0.242 ac 99.93% Impervious Runoff Depth=7.89" Tc=6.0 min CN=98 Runoff=1.9 cfs 0.159 af
SubcatchmentPR-14: Subcat PR-14	Runoff Area=0.242 ac 100.00% Impervious Runoff Depth=7.89" Tc=6.0 min CN=98 Runoff=1.9 cfs 0.159 af
SubcatchmentPR-15: Subcat PR-15	Runoff Area=0.091 ac 100.00% Impervious Runoff Depth=7.89" Tc=6.0 min CN=98 Runoff=0.7 cfs 0.060 af
SubcatchmentPR-2: Subcat PR-2	Runoff Area=0.519 ac 14.56% Impervious Runoff Depth=5.39" Tc=6.0 min CN=77 Runoff=3.3 cfs 0.233 af
SubcatchmentPR-3: Subcat PR-3	Runoff Area=3.321 ac 61.93% Impervious Runoff Depth=6.81" Tc=6.0 min CN=89 Runoff=25.0 cfs 1.886 af
SubcatchmentPR-4: Subcat PR-4	Runoff Area=2.110 ac 56.84% Impervious Runoff Depth=6.70" Tc=6.0 min CN=88 Runoff=15.7 cfs 1.177 af
SubcatchmentPR-5: Subcat PR-5	Runoff Area=1.800 ac 87.18% Impervious Runoff Depth=7.53" Tc=6.0 min CN=95 Runoff=14.2 cfs 1.129 af
SubcatchmentPR-6: Subcat PR-6	Runoff Area=0.451 ac 60.17% Impervious Runoff Depth=6.70" Tc=6.0 min CN=88 Runoff=3.4 cfs 0.252 af
SubcatchmentPR-7: Subcat PR-7	Runoff Area=0.846 ac 82.13% Impervious Runoff Depth=7.41" Tc=6.0 min CN=94 Runoff=6.6 cfs 0.523 af
SubcatchmentPR-8: Subcat PR-8	Runoff Area=0.966 ac 0.00% Impervious Runoff Depth=4.81" Tc=6.0 min CN=72 Runoff=5.4 cfs 0.387 af
SubcatchmentPR-9: Subcat PR-9	Runoff Area=0.261 ac 95.92% Impervious Runoff Depth=7.77" Tc=6.0 min CN=97 Runoff=2.1 cfs 0.169 af
Pond 1P: Sand Filter 1	Peak Elev=195.60' Storage=8,417 cf Inflow=14.2 cfs 1.129 af Outflow=14.1 cfs 1.129 af

13555.04-PR

Prepared by VHB

HydroCAD® 10.10-5a s/n 01038 © 2020 HydroCAD Software Solutions LLC

Proposed Conditions
Type III 24-hr 100-yr, 24-hr Rainfall=8.13"

Printed 9/24/2021

Pond 2P: Detention System 1	Peak Elev=173.81'	Storage=17,569 cf	Inflow=25.0 cfs	1.886 af
			Outflow=11.2 cfs	1.886 af
Pond 3P: Sand Filter 2	Peak Elev=174.29'	Storage=7,165 cf	Inflow=10.0 cfs	0.797 af
			Outflow=9.9 cfs	0.797 af
Pond 4P: Detention System 2	Peak Elev=155.80'	Storage=25,024 cf	Inflow=22.4 cfs	1.718 af
			Outflow=5.3 cfs	1.739 af
Pond 13P: Detention for Sand Filter 1	Peak Elev=197.35'	Storage=12,159 cf	Inflow=14.1 cfs	1.129 af
			Outflow=3.7 cfs	1.169 af
Pond 14P: Detention for Sand Filter 2	Peak Elev=175.56'	Storage=7,996 cf	Inflow=9.9 cfs	0.797 af
			Outflow=2.6 cfs	0.800 af
Link DP-1: Olmsted Road Drainage System			Inflow=24.4 cfs	4.350 af
			Primary=24.4 cfs	4.350 af
Link DP-2: Olmstead Road to Pleasant Street			Inflow=2.8 cfs	0.196 af
			Primary=2.8 cfs	0.196 af
Link DP-3: Intermittent Stream			Inflow=14.3 cfs	2.609 af
			Primary=14.3 cfs	2.609 af
Link DP-4: Uphams Bowl			Inflow=3.3 cfs	0.233 af
			Primary=3.3 cfs	0.233 af

Total Runoff Area = 13.239 ac Runoff Volume = 7.324 af Average Runoff Depth = 6.64"
42.98% Pervious = 5.691 ac 57.02% Impervious = 7.548 ac

Appendix C: Standard 3 Computations and Supporting Documentation

- › NRCS Web Soil Survey
- › Geotechnical Report

NRCS Mapping

Hydrologic Soil Group—Middlesex County, Massachusetts

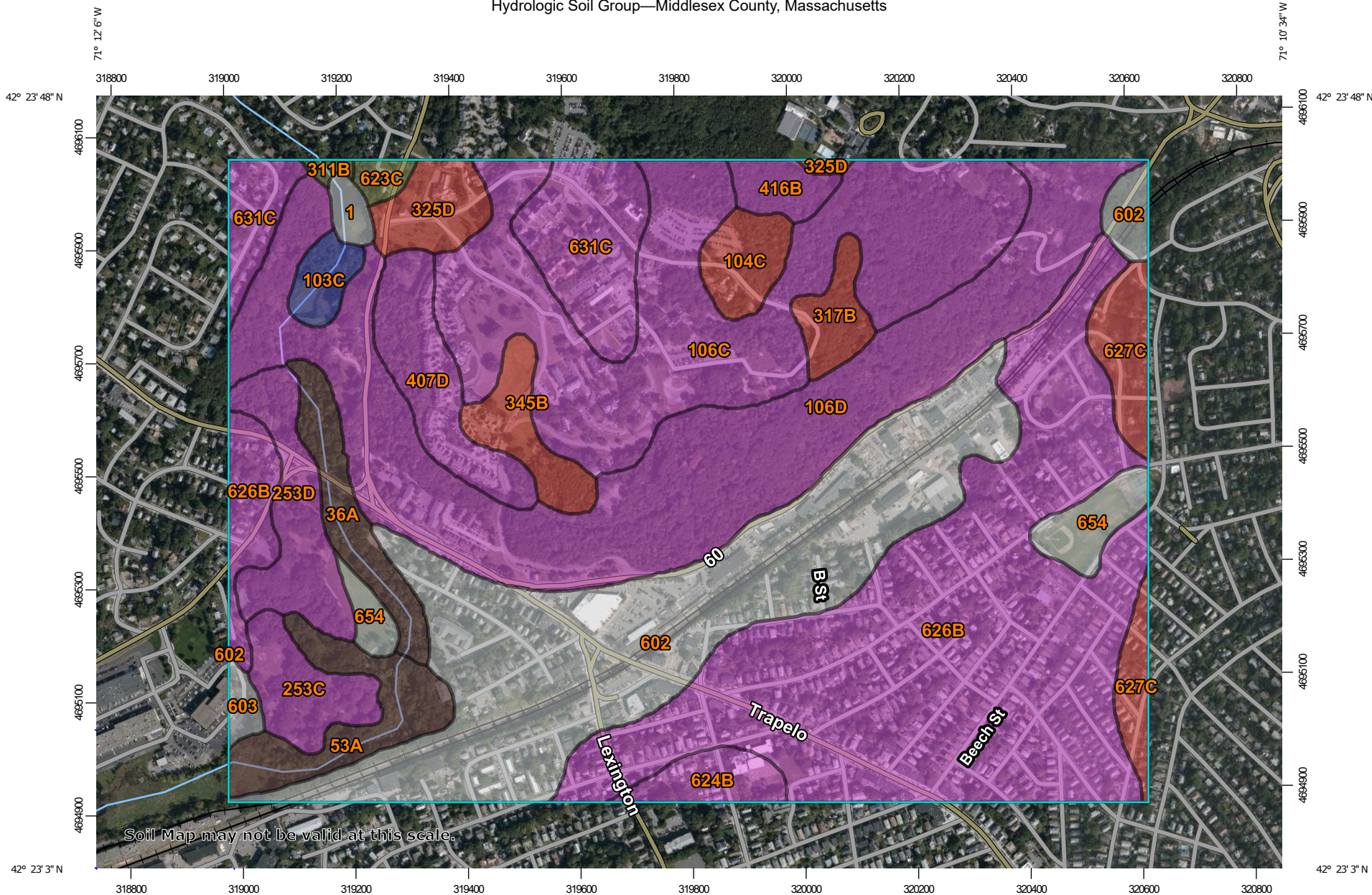

Soil Map may not be valid at this scale.

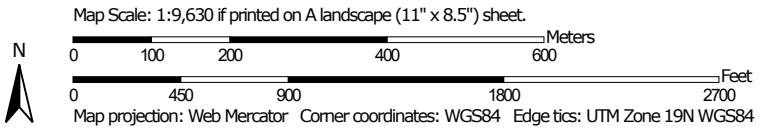

MAP LEGEND

Area of Interest (AOI)

 Area of Interest (AOI)

Soils

Soil Rating Polygons





 A
 A/D
 B
 B/D
 C
 C/D
 D
 Not rated or not available

Soil Rating Lines

 A
 A/D
 B
 B/D
 C
 C/D
 D
 Not rated or not available

Soil Rating Points

 A
 A/D
 B
 B/D

 C
 C/D
 D
 Not rated or not available

Water Features

 Streams and Canals

Transportation

 Rails
 Interstate Highways
 US Routes
 Major Roads
 Local Roads

Background

 Aerial Photography

MAP INFORMATION

The soil surveys that comprise your AOI were mapped at 1:25,000.

Warning: Soil Map may not be valid at this scale.

Enlargement of maps beyond the scale of mapping can cause misunderstanding of the detail of mapping and accuracy of soil line placement. The maps do not show the small areas of contrasting soils that could have been shown at a more detailed scale.

Please rely on the bar scale on each map sheet for map measurements.

Source of Map: Natural Resources Conservation Service
 Web Soil Survey URL:
 Coordinate System: Web Mercator (EPSG:3857)

Maps from the Web Soil Survey are based on the Web Mercator projection, which preserves direction and shape but distorts distance and area. A projection that preserves area, such as the Albers equal-area conic projection, should be used if more accurate calculations of distance or area are required.

This product is generated from the USDA-NRCS certified data as of the version date(s) listed below.

Soil Survey Area: Middlesex County, Massachusetts
 Survey Area Data: Version 20, Jun 9, 2020

Soil map units are labeled (as space allows) for map scales 1:50,000 or larger.

Date(s) aerial images were photographed: Sep 11, 2019—Oct 5, 2019

The orthophoto or other base map on which the soil lines were compiled and digitized probably differs from the background imagery displayed on these maps. As a result, some minor shifting of map unit boundaries may be evident.

Hydrologic Soil Group

Map unit symbol	Map unit name	Rating	Acres in AOI	Percent of AOI
1	Water		1.9	0.4%
36A	Saco mucky silt loam, 0 to 1 percent slopes	B/D	8.8	1.9%
53A	Freetown muck, ponded, 0 to 1 percent slopes	B/D	11.5	2.5%
103C	Charlton-Hollis-Rock outcrop complex, 8 to 15 percent slopes	B	3.5	0.8%
104C	Hollis-Rock outcrop-Charlton complex, 0 to 15 percent slopes	D	5.8	1.2%
106C	Narragansett-Hollis-Rock outcrop complex, 3 to 15 percent slopes	A	66.5	14.4%
106D	Narragansett-Hollis-Rock outcrop complex, 15 to 25 percent slopes	A	77.0	16.7%
253C	Hinckley loamy sand, 8 to 15 percent slopes	A	8.1	1.8%
253D	Hinckley loamy sand, 15 to 25 percent slopes	A	12.1	2.6%
311B	Woodbridge fine sandy loam, 0 to 8 percent slopes, very stony	C/D	0.7	0.1%
317B	Scituate fine sandy loam, 3 to 8 percent slopes, extremely stony	D	4.9	1.1%
325D	Newport channery fine sandy loam, 8 to 25 percent slopes	D	7.1	1.5%
345B	Pittstown silt loam, 3 to 8 percent slopes	D	7.0	1.5%
407D	Charlton fine sandy loam, 15 to 25 percent slopes, extremely stony	A	12.1	2.6%
416B	Narragansett silt loam, 3 to 8 percent slopes, very stony	A	4.0	0.9%
602	Urban land		76.3	16.5%
603	Urban land, wet substratum		1.7	0.4%

Map unit symbol	Map unit name	Rating	Acres in AOI	Percent of AOI
623C	Woodbridge-Urban land complex, 3 to 15 percent slopes	C/D	1.6	0.4%
624B	Haven-Urban land complex, 0 to 8 percent slopes	A	5.2	1.1%
626B	Merrimac-Urban land complex, 0 to 8 percent slopes	A	108.1	23.5%
627C	Newport-Urban land complex, 3 to 15 percent slopes	D	10.1	2.2%
631C	Charlton-Urban land-Hollis complex, 3 to 15 percent slopes, rocky	A	19.8	4.3%
654	Udorthents, loamy		7.2	1.6%
Totals for Area of Interest			461.1	100.0%

Description

Hydrologic soil groups are based on estimates of runoff potential. Soils are assigned to one of four groups according to the rate of water infiltration when the soils are not protected by vegetation, are thoroughly wet, and receive precipitation from long-duration storms.

The soils in the United States are assigned to four groups (A, B, C, and D) and three dual classes (A/D, B/D, and C/D). The groups are defined as follows:

Group A. Soils having a high infiltration rate (low runoff potential) when thoroughly wet. These consist mainly of deep, well drained to excessively drained sands or gravelly sands. These soils have a high rate of water transmission.

Group B. Soils having a moderate infiltration rate when thoroughly wet. These consist chiefly of moderately deep or deep, moderately well drained or well drained soils that have moderately fine texture to moderately coarse texture. These soils have a moderate rate of water transmission.

Group C. Soils having a slow infiltration rate when thoroughly wet. These consist chiefly of soils having a layer that impedes the downward movement of water or soils of moderately fine texture or fine texture. These soils have a slow rate of water transmission.

Group D. Soils having a very slow infiltration rate (high runoff potential) when thoroughly wet. These consist chiefly of clays that have a high shrink-swell potential, soils that have a high water table, soils that have a claypan or clay layer at or near the surface, and soils that are shallow over nearly impervious material. These soils have a very slow rate of water transmission.

If a soil is assigned to a dual hydrologic group (A/D, B/D, or C/D), the first letter is for drained areas and the second is for undrained areas. Only the soils that in their natural condition are in group D are assigned to dual classes.

Rating Options

Aggregation Method: Dominant Condition

Component Percent Cutoff: None Specified

Tie-break Rule: Higher

Geotechnical Data

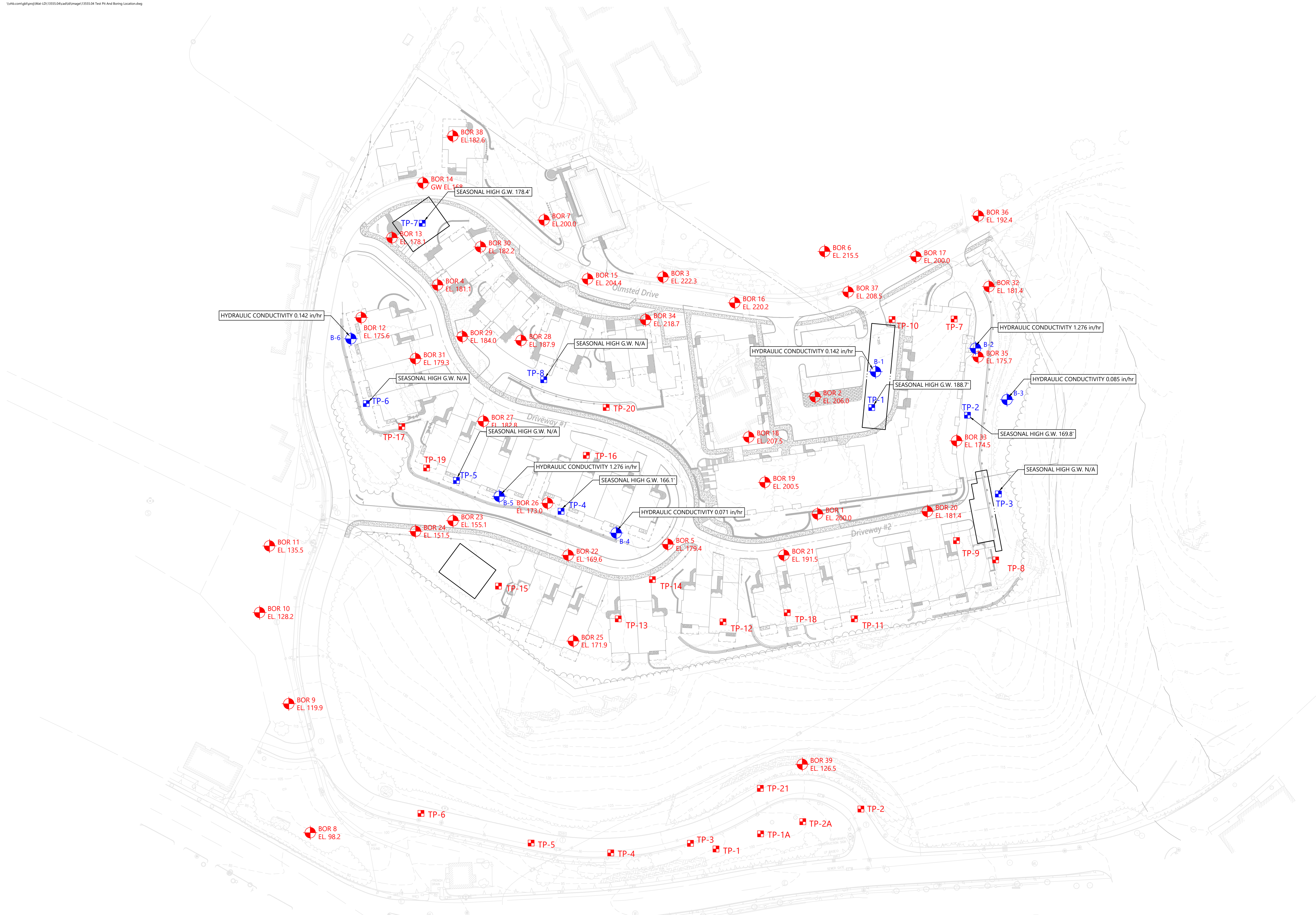

Legend

- Historic Test Pits and Boring Locations
- Recent Test Pits and Boring Locations

Test pit and Boring locations

Residences at Bel Mont

Belmont, Massachusetts

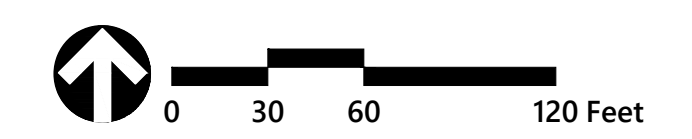



NORTHEAST
GEOTECHNICAL, INC.
Delivering Practical Engineering Solutions

**SUBSURFACE EXPLORATION AND
BOREHOLE PERMEABILITY TESTING REPORT
PROPOSED RESIDENCES AT BEL MONT
FORMER MCLEAN HOSPITAL SITE
BELMONT, MASSACHUSETTS**

Prepared For:
Northland Residential Corp.
80 Beharrell Road, Suite E
Concord, MA 01742

Prepared By:
Northeast Geotechnical, Inc.
166 Raymond Hall Drive
North Attleboro, MA 02760

Project No. O432.01
June 18, 2020



NORTHEAST
GEOTECHNICAL, INC.
Delivering Practical Engineering Solutions

June 18, 2021

Project No. O432.01

Mr. John C. Dawley
Northland Residential Corp.
80 Beharrell Road, Suite E
Concord, MA 01742

SUBJECT: Subsurface Exploration and Borehole Permeability Testing Report
Proposed Residences at Bel Mont
Former McLean Hospital Site
Belmont, MA

Dear Jack:

Northeast Geotechnical, Inc. is pleased to present our geotechnical engineering report for the proposed stormwater management areas being considered at the subject site. The objective of our studies has been to provide recommendations for use in design of the stormwater management areas by VHB. We accomplished our objective by assessing the general subsurface soil, bedrock and groundwater conditions within the proposed stormwater management areas and by performing in-situ borehole permeability testing in the test borings advanced in these areas. Our studies have been performed in accordance with our proposal to you dated May 17, 2021. This report is subject to the Limitations and Service Constraints included in Appendix A of the attached report.

We have enjoyed working with you on this project and look forward to continuing our involvement during future design and construction phases. If you have any questions or require additional information, please contact Glenn Olson, P.E. at 508-274-0887 or at golson@northeastgeotechnical.com.

Sincerely,

Northeast Geotechnical, Inc.

Christian B. Rice, P.E.
Senior Project Engineer

Glenn A. Olson, P.E.
Principal Engineer

TABLE OF CONTENTS

1.0 INTRODUCTION	1
2.0 EXPLORATORY SUBSURFACE EXPLORATION PROGRAM.....	1
3.0 BOREHOLE PERMEABILITY TESTING	3
4.0 LABORATORY TESTING.....	3
5.0 GENERAL SUBSURFACE CONDITIONS.....	3
5.1 Existing Fill	4
5.2 Natural Topsoil.....	4
5.3 Natural Subsoil	4
5.4 Natural Glacial Till.....	4
5.5 Refusal Conditions	5
5.6 Groundwater	5
6.0 CONCLUSIONS AND RECOMMENDATIONS	5
6.1 Proposed Infiltration System #1	6
6.2 Proposed Infiltration System #2	7
6.3 Proposed Infiltration System #3	7
6.4 Proposed Infiltration System #4	8
6.5 Proposed Infiltration System #5	8
6.6 Proposed Infiltration System #6	9

FIGURE

- 1 Subsurface Exploration Location Plan

APPENDICES

- A Limitations and Service Constraints
- B Test Boring Logs
- C Test Pit Logs
- D Test Pit Photos
- E Laboratory Test Results



1.0 INTRODUCTION

This report summarizes the results of eight test pits and six soil test borings with borehole permeability testing performed for the proposed Residences at Bel Mont project located at the former McLean Hospital site in Belmont, Massachusetts. The test pits, test borings and permeability testing were performed in support of the proposed stormwater infiltration systems that Vanasse Hangen Brustlin, Inc. (VHB) intends to design as part of the proposed residential development.

Our understanding of the existing site conditions and proposed development is based on our conversations with Northland Residential and VHB along with review of the following:

- Plan titled “*Soil Exploration Plan*” annotated with details of the proposed stormwater infiltration systems, dated April 26, 2021, prepared by VHB;
- Plan titled “*Soil Exploration Plan Existing Conditions*”, Drawing No. Fig 2 dated May 6, 2021, prepared by VHB;
- Three-dimensional renderings of the proposed project prepared by The Architectural Team, Inc., dated March 18, 2021; and
- “*Geotechnical Engineering Study – ARC Belmont Campus*” dated December 12, 2000, prepared by Weidlinger Associates, Inc.

The site, which is bound by Olmstead Drive to the north and west, and woodlands to the south and east, is primarily undeveloped woodlands. A vacant building and associated paved parking exist near the north/central portion of the site. A grass landscaped area with a stormwater management basin is present at the northwest portion of the site along Olmstead Drive. Water and sewer lines span the perimeter of the site along the east and south boundaries. The site generally slopes moderately to steeply downward from its high point at approximately elevation (El) 210 feet near the vacant building outward to the west, south, and east to approximately El 139 feet.

Multiple residential buildings are planned as part of the proposed development. Additionally, six infiltration systems (designated Infiltration Systems #1 through #6) are planned across the site. Proposed final grades and bottom-of-system elevations for each of the systems are summarized in Section 6.0 of this report as designed by VHB.

2.0 EXPLORATORY SUBSURFACE EXPLORATION PROGRAM

Northeast Geotechnical observed a subsurface exploration program consisting of six soil test borings (B-1 through B-6) and eight test pits (TP-1 through TP-8) at the subject site. The test borings were performed on June 2, 3, and 4 by Soil X Corp. of Leominster, Massachusetts. The test pits were performed on June 1 and 2, 2021 by Lussier Corporation of Natick, Massachusetts.

The test boring and test pit locations were survey located in the field by VHB. Select test pits and test borings were offset from the staked locations for accessibility with the subsurface exploration equipment. The approximate test boring and test pit locations are shown on the attached Subsurface Exploration Location Plan (Figure No. 1). Existing ground surface elevations depicted on the individual exploration logs (see Appendices B and C of this report) were estimated by interpolating between contours on available project plans.

The test borings were advanced using an all terrain vehicle (ATV)-mounted Acker AD-II drill rig. Test borings were advanced using a combination of 4¼-inch inside diameter continuous flight hollow-stem augers (HSAs), 3-inch diameter continuous flight solid stem augers (SSAs), and 3-inch diameter flush-joint casing with roller bit by drive-and-wash drilling techniques to depths of approximately 6.5± to 12± feet below existing ground surface. Borings B-1 and B-2 encountered refusal conditions on probable boulders while drilling, so the borings were offset then continued as B-1A and B-2A, respectively. Five of the test borings terminated on a refusal condition which in our opinion, appears to represent bedrock. Test boring B-3 terminated without refusal in natural glacial till at a depth of approximately 12± feet below existing ground surface.

Standard Penetration Testing (SPT) was performed during each test boring. The SPT was performed at increments of 5 feet or less. The SPT was performed by driving a standard 2-inch outside diameter split spoon sampler up to 24 inches using a 140-pound auto-trip hammer falling 30 inches. The number of hammer blows required to drive the sampler in 6-inch increments is recorded on the boring logs attached in Appendix B. The sum of the blows required to drive the split spoon sampler from the 6 to 12-inch interval and the 12 to 18-inch interval is defined as the Standard Penetration Resistance of the soil.

The soil samples retrieved in the split spoon sampler during each SPT were visually described in the field by Northeast Geotechnical, Inc. personnel using Burmister's soil descriptions. The visual descriptions, the hammer blow counts required to drive the split spoon sampler during the SPTs, groundwater observations, approximate changes in soil/rock strata, and other observations are shown on the boring logs contained in Appendix B. Note that the soil descriptions are representative of the minus 1.4± inch size fraction of the overall soil deposits sampled as that is the inside diameter of the split spoon sampler.

The test pits were performed with a Case CX145CSR excavator, with a 1± cubic yard capacity toothed bucket and a 20± foot maximum reach. The test pits were advanced to depths ranging from approximately 2.8± to 10± feet below the existing ground surface and terminated upon refusal on apparent bedrock. The soils/rock exposed in the test pits were visually described in the field by a Northeast Geotechnical, Inc. licensed Massachusetts Soil Evaluator using the USDA soil textural classification system.

The depths of estimated seasonal high groundwater in the test pits were based on the observed ground water conditions and the presence of redoximorphic features. The visual descriptions, groundwater observations, approximate changes in soil/rock strata, and other observations are shown on the test pit logs contained in Appendix C. Test pit photographs are presented in Appendix D.

3.0 BOREHOLE PERMEABILITY TESTING

Falling head borehole permeability testing was performed in each boring at depths of about 5± to 9.6± feet below existing ground surface within the natural glacial till soil stratum. The purpose of the testing was to assess the hydraulic conductivity of the natural glacial till soils. The testing consisted of falling head tests as described by the U.S. Bureau of Reclamation. The testing performed was consistent with procedures described by Hvorslev (1951). Two trials of the falling head test were performed in each test. We have developed recommended hydraulic conductivity design values of the glacial till at each proposed infiltration system based on the results of the borehole permeability testing. Our recommended hydraulic conductivity values are presented in Section 6.0.

4.0 LABORATORY TESTING

Northeast Geotechnical submitted selected representative samples of the natural glacial till soil collected from the test borings and test pits to Thielsch Engineering of Cranston, Rhode Island for laboratory testing to assess basic geotechnical engineering characteristics of the soils. The laboratory testing consisted of twelve combined sieve and hydrometer tests with USDA soil textural classifications. Samples of the glacial till soil collected at the approximate depths of the borehole permeability testing were included with the laboratory testing program. The test results are summarized below and attached to this report in Appendix E.

Exploration I.D.	USDA Soil Textural Classification	Exploration I.D.	USDA Soil Textural Classification
B-1/B-1A	Loamy Sand	TP-1	Loamy Sand
B-2/B-2A	Sandy Loam	TP-2	Sandy Loam
B-3	Sandy Loam	TP-3	Sandy Loam
B-4	Sandy Loam	TP-4	Loamy Sand
B-5	Sandy Loam	TP-5	Loamy Sand
B-6	Sandy Loam	TP-6	Loamy Sand

5.0 GENERAL SUBSURFACE CONDITIONS

The generalized subsurface conditions observed in the test borings and test pits consists of natural topsoil overlying natural subsoil which in turn overlies natural glacial till soil and then apparent bedrock. Subsurface explorations test boring B-2 and test pit TP-2, which were performed in the vicinity of the existing utility lines, encountered existing fill overlying buried topsoil and subsoil, which in turn overlies natural glacial till and then apparent bedrock. Test pit TP-2, located in the grassy

area near Olmstead Drive at the northwest portion of the site, encountered existing topsoil fill and granular fill directly above apparent bedrock.

5.1 Existing Fill

Granular existing fill was encountered at the ground surface in test pit TP-2, below the topsoil fill in TP-7, and below the topsoil fill in test boring B-2 extending to depths of approximately 1.7± to 5± feet below ground surface. The granular fill appeared to generally consist of medium dense to very dense, gray to brown to dark brown, fine to coarse gravel with about 25± to 50± percent fine to medium or fine to coarse sand, 25± to 45± percent silt, and up to about 5± to 10± percent brick and asphalt fragments. Occasional cobbles and boulders up to about 36± inches in diameter were observed within the existing granular fill in TP-2.

Approximately 6± to 7± inches of topsoil fill was encountered at the ground surface of B-2 and TP-7 and buried topsoil layers were encountered beneath the existing granular fill in B-2 and TP-2. The buried topsoil layers were observed to be approximately 4± to 7± inches thick, extending to depths of approximately 4.3± to 5.3± feet below ground surface. The topsoil fill and buried topsoil layers appeared to generally consist of loose, dark brown, silt with up to about 5± to 15± percent fine to medium sand and fine gravel, and up to about 5± to 10± percent roots.

A buried subsoil layer was encountered beneath the buried topsoil layer in test boring B-2 and test pit TP-2 and was observed to be approximately 1± to 1.7± feet thick, extending to depths of approximately 5.3± to 7± feet below ground surface, respectively. The buried subsoil layer appeared to generally consist of medium dense, light brown, silt with up to about 5± to 10± percent fine sand and fine gravel, and up to about 5± to 10± percent roots.

5.2 Natural Topsoil

Natural topsoil was encountered at the ground surface of the explorations, except for test boring B-2 and test pits TP-2 and TP-7. The natural topsoil was observed to be about 4± to 10± inches thick and generally consisted of very loose to loose, brown to dark brown, silt with about 5± to 25± percent roots, about 5± to 15± percent fine or fine to medium sand, and up to about 5± percent fine gravel. Occasional cobbles and boulders were observed at the ground surface in the vicinity of the explorations.

5.3 Natural Subsoil

Natural subsoil was encountered beneath the natural topsoil in the explorations, except for test boring B-2 and test pits TP-2 and TP-7. The natural subsoil was observed to be about 1.1± to 2.7± feet thick extending to depths of approximately 1.5± to 3.4± feet. The subsoil generally consisted of loose to medium dense, light brown to brown, silt with about 5± to 25± percent fine sand, about 5± to 15± percent fine or fine to coarse gravel, and up to about 5± to 10± percent roots. Occasional cobbles were observed in the subsoil layer in the test pits.

5.4 Natural Glacial Till

Apparent natural glacial till was encountered below the natural subsoil and/or buried subsoil in each of the test borings and test pits, except for TP-7, at depths ranging from approximately 1.5± to 7± feet

below ground surface. The glacial till extended down to apparent bedrock in the test pits and to possible bedrock (i.e., drilling refusal conditions) in the test borings at depths ranging from approximately 3.6± to 10± feet. Test boring B-3 terminated without refusal in the natural glacial till at a depth of approximately 12± feet.

The glacial till appeared to generally consist of medium dense to very dense, gray to brown, fine to medium sand with about 15± to 45± percent fine to coarse gravel and 15± to 35± percent silt. Occasional to frequent cobbles and boulders ranging from about 18± to 48± inches in diameter were observed in the test pits.

5.5 Refusal Conditions

Refusal conditions were encountered in each of the explorations, except for test boring B-3. The test borings (except B-3) terminated upon sampler and/or roller bit refusal on possible bedrock surfaces and the test pits terminated upon visually apparent bedrock at depths ranging from approximately 2.8± to 12± feet below ground surface. Test pit TP-7 was advanced about one foot into apparent fractured bedrock before encountering refusal to further penetration on visually apparent bedrock approximately 2.8± feet below ground surface.

5.6 Groundwater

Perched groundwater was encountered in test pit TP-7 at a depth of approximately 1.6± feet below existing ground surface. Groundwater was not observed in the remaining test pits. Groundwater was not observed in the test borings to depths when water was introduced into the borehole via drive-and-wash drilling methods. Groundwater levels will fluctuate due to variations in temperature, precipitation, and other factors. Additionally, groundwater may become temporarily perched above dense glacial till and/or bedrock surfaces, as was observed in test pit TP-7. Therefore, groundwater levels at any time could be different from that reported herein.

The depths of estimated seasonal high groundwater in the test pits were based on the observed ground water conditions and the presence of redoximorphic features. Signs indicative of seasonal high groundwater were observed in test pits TP-1, TP-2, TP-4, and TP-7 at depths ranging from approximately 1.6± to 7.3± feet below existing ground surface. Such indications were not observed in the remaining test pits or test borings. Refer to the individual exploration logs in Appendices B and C for additional information.

6.0 CONCLUSIONS AND RECOMMENDATIONS

The following conclusions and recommendations are presented subject to the attached Limitations and Service Constraints in Appendix A.

Six stormwater infiltration systems are proposed as part of the proposed development. Test borings B-1 through B-6 and test pits TP-1 through TP-6 were advanced within the planned system footprints. Each proposed infiltration system has different proposed final grades and bottom-of-system elevations. A summary of the subsurface conditions encountered at each proposed stormwater infiltration system as compared to the proposed system elevations are presented in the tables below.

Based on available project plans, a raise in grade of approximately 3± to 13± feet will be required to achieve final grades surrounding the proposed stormwater infiltration systems. We expect organic topsoil and subsoil will be stripped prior to fill placement. Based on the results of the explorations, the majority of the stormwater infiltration system areas will have bottom-of-stone elevations either within the glacial till or within required fill placement above existing grades, with approximately 1± to greater than 12± feet of separation between the bottom-of-stone and bedrock surface. An exception is at the east end of Infiltration System #5 where apparent bedrock was encountered in boring B-5 at approximately 1.5± feet above planned bottom-of-stone elevation.

A recommended maximum hydraulic conductivity rate of the natural glacial till soils encountered in each proposed infiltration system is also presented below based on the results of the borehole permeability testing.

6.1 Proposed Infiltration System #1

Proposed Infiltration System #1		
Exploration I.D.	Existing Ground Surface Elevation (feet)	Subsurface Profile
B-1	194± feet	Topsoil/Subsoil: El 194± to 192± feet
		Natural Glacial Till Soil: El 192± to 184.5± feet ¹
		Top of Apparent Bedrock: El 184.5± feet ²
TP-1	194± feet	Topsoil/Subsoil: El 194± to 191± feet
		Natural Glacial Till: El 191± to 186±
		Top of Apparent Bedrock: El 186± feet
1. Borehole permeability test performed within glacial till at approximately El 188± feet. 2. Top of possible bedrock surface implied by split spoon sampler refusal.		

Proposed Infiltration System Details:

- Proposed Finish Grade = El 204± feet
- Bottom of Infiltration System = El 191.5 feet
- Bottom of Stone = El 191 feet (5± to 6.5± feet of separation between bottom of stone and apparent bedrock)
- Recommended hydraulic conductivity of glacial till = 1×10^{-4} cm/sec

6.2 Proposed Infiltration System #2

Proposed Infiltration System #2		
Exploration I.D.	Existing Ground Surface Elevation (feet)	Subsurface Profile
B-2	182± feet	Existing Fill: El 182± to 177± feet
		Buried Topsoil: El 177± to 181.5± feet
		Buried Subsoil: El 181.5± to 175± feet
		Natural Glacial Till: El 175± to 172± feet ¹
		Top of Apparent Bedrock: El 172± feet ²
TP-2	177± feet	Existing Fill: El 177± to 173± feet
		Buried Topsoil: El 173± to 172.5± feet
		Buried Subsoil: El 172.5± to 172± feet
		Natural Glacial Till: El 172± to 167± feet
		Top of Apparent Bedrock: El 167± feet
1. Borehole permeability test performed within glacial till at approximately El 172.5± feet. 2. Top of apparent bedrock surface implied by split spoon sampler refusal.		

Proposed Infiltration System Details:

- Proposed Finish Grade = El 186± to El 192± feet
- Pipe Invert = El 179 feet
- Bottom of Stone = El 178 feet (6± to 11± feet of separation between bottom of stone and bedrock)
- Recommended hydraulic conductivity of glacial till = 9×10^{-4} cm/sec

6.3 Proposed Infiltration System #3

Proposed Infiltration System #3		
Exploration I.D.	Existing Ground Surface Elevation (feet)	Subsurface Profile
B-3	169± feet	Topsoil/Subsoil: El 169± to 167± feet
		Glacial Till: El 167± to <157± feet ^{1,2}
TP-3	167± feet	Topsoil/Subsoil: El 167± to 164.5± feet
		Glacial Till: El 164.5± to 159± feet
		Top of Bedrock: El 159± feet
1. Borehole permeability test performed within glacial till at approximately El 163± feet. 2. Test boring terminated in glacial till prior to encountering apparent bedrock surface.		

Proposed Infiltration System Details:

- Proposed Finish Grade = El 178± feet
- Pipe Invert = El 170 feet
- Bottom of Stone = El 169 feet (10± to >12± feet of separation between bottom of stone and bedrock)
- Recommended hydraulic conductivity of glacial till = 6×10^{-5} cm/sec

6.4 Proposed Infiltration System #4

Proposed Infiltration System #4		
Exploration I.D.	Existing Ground Surface Elevation (feet)	Subsurface Profile
B-4	174± feet	Topsoil/Subsoil: El 174± to 172± feet
		Glacial Till: El 172± to 164± feet ¹
		Top of Bedrock: El 164± feet ²
TP-4	172± feet	Topsoil/Subsoil: El 172± to 170± feet
		Glacial Till: El 170± to 165.5± feet
		Top of Bedrock: El 165.5± feet
1. Borehole permeability test performed within glacial till at approximately El 166± feet. 2. Top of bedrock surface implied by roller bit refusal.		

Proposed Infiltration System Details:

- Proposed Finish Grade = El 175± to 176± feet
- Pipe Invert = El 170 feet
- Bottom of Stone = El 169 feet (4± to 5± feet of separation between bottom of stone and bedrock)
- Recommended hydraulic conductivity of glacial till = 1×10^{-5} cm/sec

6.5 Proposed Infiltration System #5

Proposed Infiltration System #5		
Exploration I.D.	Existing Ground Surface Elevation (feet)	Subsurface Profile
B-5	173± feet	Topsoil/Subsoil: El 173± to 171.5± feet
		Glacial Till: El 171.5± to 166.5± feet ¹
		Top of Bedrock: El 166.5± feet ²
TP-5	166± feet	Topsoil/Subsoil: El 166± to 164± feet
		Glacial Till: El 164± to 158± feet
		Top of Bedrock: El 158± feet
1. Borehole permeability test performed within glacial till at approximately El 168± feet. 2. Top of apparent bedrock surface implied by roller bit refusal.		

Proposed Infiltration System Details:

- Proposed Finish Grade = El 176± to 177± feet
- Pipe Invert = El 166 feet
- Bottom of Stone = El 165 feet (7± feet of separation between bottom of stone and bedrock, to bedrock being at 1.5± feet above bottom of stone)
- Recommended hydraulic conductivity of glacial till = 9×10^{-4} cm/sec

6.6 Proposed Infiltration System #6

Proposed Infiltration System #6		
Exploration I.D.	Existing Ground Surface Elevation (feet)	Subsurface Profile
B-6	171± feet	Topsoil/Subsoil: El 171± to 169± feet
		Glacial Till: El 169± to 165± feet ¹
		Top of Bedrock: El 165± feet ²
TP-6	167± feet	Topsoil/Subsoil: El 167± to 165± feet
		Glacial Till: El 165± to 163± feet
		Top of Bedrock: El 163± feet
1. Borehole permeability test performed within glacial till at approximately El 166± feet. 2. Top of apparent bedrock surface implied by roller bit refusal.		

Proposed Infiltration System Details:

- Proposed Finish Grade = El 171± to 176± feet
- Pipe Invert = El 167 feet
- Bottom of Stone = El 166 feet (1± to 3± feet of separation between bottom of stone and bedrock)
- Recommended hydraulic conductivity of glacial till = 1×10^{-4} cm/sec

FIGURE



NOTES:

1. BASE MAP DEVELOPED FROM PLAN TITLED "SOIL EXPLORATION PLAN", ANNOTATED WITH PROPOSED STORMWATER INFILTRATION SYSTEM DETAILS, DATED APRIL 26, 2021, PREPARED BY VANASSE HANGEN BRUSTLIN, INC. (VHB).
2. PROPOSED TEST BORING AND TEST PIT LOCATIONS ESTABLISHED BY OTHERS. SOME TEST PITS AND TEST BORINGS OFF-SET FROM STAKED LOCATIONS FOR ACCESSIBILITY WITH EQUIPMENT. EXPLORATION LOCATIONS SHOWN ON THIS PLAN SHOULD BE CONSIDERED APPROXIMATE.
3. TEST BORINGS AND TEST PITS OBSERVED AND LOGGED BY NORTHEAST GEOTECHNICAL, INC. PERSONNEL.

LEGEND:

- TEST BORINGS PERFORMED BY SOIL X CORP. OF LEOMINSTER, MA ON JUNE 2, 3, AND 4, 2021.
- TEST PITS EXCAVATED BY LUSSIER CORPORATION OF NATICK, MA ON JUNE 1 AND 2, 2021.

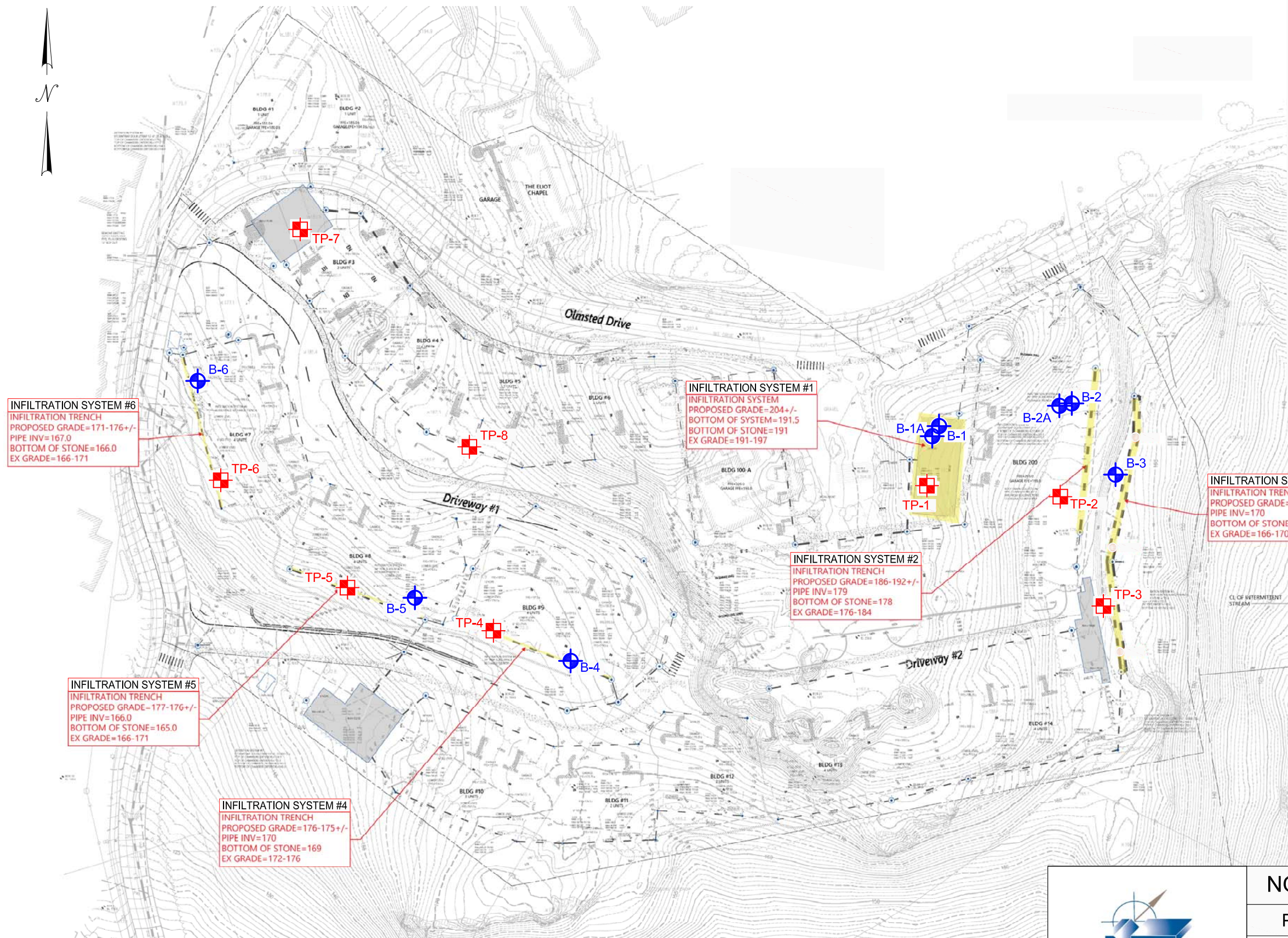

INFILTRATION SYSTEM #6
 INFILTRATION TRENCH
 PROPOSED GRADE=171-176+/-
 PIPE INV=167.0
 BOTTOM OF STONE=166.0
 EX GRADE=166-171

INFILTRATION SYSTEM #1
 INFILTRATION TRENCH
 PROPOSED GRADE=204+/-
 BOTTOM OF SYSTEM=191.5
 EX GRADE=191-197

INFILTRATION SYSTEM #3
 INFILTRATION TRENCH
 PROPOSED GRADE=178+/-
 PIPE INV=170
 BOTTOM OF STONE=169
 EX GRADE=166-170

INFILTRATION SYSTEM #2
 INFILTRATION TRENCH
 PROPOSED GRADE=186-192+/-
 PIPE INV=179
 BOTTOM OF STONE=178
 EX GRADE=176-184

INFILTRATION SYSTEM #5
 INFILTRATION TRENCH
 PROPOSED GRADE=177-176+/-
 PIPE INV=166.0
 BOTTOM OF STONE=165.0
 EX GRADE=166-171

INFILTRATION SYSTEM #4
 INFILTRATION TRENCH
 PROPOSED GRADE=176-175+/-
 PIPE INV=170
 BOTTOM OF STONE=169
 EX GRADE=172-176

 NORTHEAST GEOTECHNICAL	NORTHEAST GEOTECHNICAL, INC.	
	PROPOSED RESIDENCES AT BEL MONT	
	FORMER MCLEAN HOSPITAL SITE BELMONT, MA	
	SUBSURFACE EXPLORATION LOCATION PLAN	
Project No.: O432.01	Drawn By: JJP	Reviewed By: G.OLSON, P.E.
Date: 6/10/2021	Scale: 1"=100'	Figure No.: 1

APPENDIX A

Limitations and Service Constraints

LIMITATIONS AND SERVICE CONSTRAINTS

Geotechnical Engineering Consulting Services

The opinions, conclusions and recommendations presented in this report are based upon the scope of services, information obtained through the performance of the services, and the schedule as agreed upon by Northeast Geotechnical, Inc. and the party for whom this report was originally prepared. This report is an instrument of professional service and was prepared in accordance with the generally accepted standards and level of skill and care under similar conditions and circumstances established by the geotechnical consulting industry. No representation, warranty, or guarantee, express or implied, is intended or given. To the extent that Northeast Geotechnical, Inc. relied upon any information prepared by other parties not under contract to Northeast Geotechnical, Inc. , Northeast Geotechnical, Inc. makes no representation as to the accuracy or completeness of such information. This report is expressly for the sole and exclusive use of the party for whom this report was originally prepared and/or other specifically named parties have the right to make use of and rely upon this report. Reuse of this report or any portion thereof for other than its intended purpose, or if modified, or if used by third parties, shall be at the user's sole risk.

Furthermore, nothing contained in this document shall relieve any other party of its responsibility to abide by contract documents and applicable laws, codes, regulations, or standards.

Subsurface Explorations and Testing

Results of any observations, subsurface exploration or testing, and any findings presented in this report apply solely to conditions existing at the time when Northeast Geotechnical, Inc.'s exploratory work was performed. It must be recognized that any such observations and exploratory or testing activities are inherently limited and do not represent a conclusive or complete characterization. Conditions in other parts of the project site may vary from those at the locations where data were collected and conditions can change with time. Northeast Geotechnical, Inc.'s ability to interpret exploratory and test results is related to the availability of the data and the extent of the exploratory and testing activities.

The findings, conclusions and recommendations submitted in this report are based, in part, on data obtained from subsurface borings, test pits, and specific, discrete sampling locations. The nature and extent of variation between these test locations, which may be widely spaced, may not become evident until construction. If variations are subsequently encountered, it will be necessary to re-evaluate the conclusions and recommendations of this report.

Correlations and descriptions of subsurface conditions presented in boring logs, test pit logs, subsurface profiles, and other materials are approximate only. Subsurface conditions may vary significantly from those encountered in borings and sampling locations and transitions between subsurface materials may be gradual or highly variable.

Conditions at the time water level measurements and other subsurface observations were made are presented in the boring logs or other sampling forms. This field data has been reviewed and interpretations provided in this report. However, groundwater levels may be variable and may fluctuate due to variation in precipitation, temperature, and other factors. Therefore, groundwater levels at the site at any time may be different than stated in this report.

Review

In the event that any change in the nature, design, or location of the proposed structure(s) is planned, the conclusions and recommendations in this report shall not be considered valid unless the changes are reviewed and the conclusions and recommendations of this report are modified or verified in writing.

Northeast Geotechnical, Inc. should be provided the opportunity for a general review of final design plans and specifications to assess that our recommendations have been properly interpreted and included in the design and construction documents.

Construction

To verify conditions presented in this report and modify recommendations based on field conditions encountered in the field, Northeast Geotechnical, Inc. should be retained to provide geotechnical engineering services during the construction phase of the project. This is to observe compliance with design concepts, specifications, and recommendations contained in this report, and to verify and refine our recommendations as necessary in the event that subsurface conditions differ from those anticipated prior to the start of construction.

APPENDIX B

Test Boring Logs

NORTHEAST GEOTECHNICAL, INC.

TEST BORING LOG	Project: <u>Proposed Residences at Bel Mont</u> <u>Former McLean Hospital Site</u> <u>Belmont, MA</u>	Test Boring No.: <u>B-1/B-1A</u> Page: <u>1 of 1</u> File No.: <u>O432.01</u> Reviewed By: <u>Glenn Olson, P.E.</u>
------------------------	---	--

Boring Co. <u>Soil X Corp.</u>	Date/Weather: <u>6-3-2021 / Overcast, 60s to 70s °F</u>
Foreman: <u>Rich Bonnetti</u>	Northeast Geotechnical Observer: <u>Christian Rice, P.E.</u>
Boring Equipment: <u>Acker AD-II Drill Rig, 2.0" O.D. Split Spoon</u>	Test Boring Location: <u>See Exploration Location Plan</u>
<u>3" Diam. Solid-Stem Augers/4' then 3" Diam.</u>	Ground Surface Elevation: <u>194± feet</u>
<u>Casing w/ Roller Bit, 140 lb Auto Hammer</u>	Depth to Water: <u>See Note 3</u>

Sample Data							Strata Change	Sample Description
No.	Depth	Pen.	Rec.	Blows per 6 in.	Rem.			
S-1A	0-0.3'	4"	4"	3	1	Topsoil, 0.3'±	Loose, dark brown, SILT, some Roots, trace F. Sand	
S-1B	0.3-2'	20"	4"	2-23-62		Subsoil, 2'±	Medium dense, SILT, little F. Sand, little F. Gravel, trace Roots	
S-2	2-2.7'	8"	4"	20-50/2"	2	Natural Glacial Till	Very dense, gray-brown, F/C SAND and F/C GRAVEL, some (-) Silt, trace (-) Roots, moist. Rock fragments in sampler tip.	
S-3	4-6'	24"	18"	24-32-34-46	3			
					4,5			
S-4	6-8'	24"	12"	28-35-44-35				
S-5	8-9.5'	18"	6"	42-39-50/6"				
					6	9.5'±	Very dense, gray, F/C SAND, some Silt, little (+) F/C Gravel	
						Refusal	Bottom of boring at 9.5± feet	

Notes: 1) Bedrock outcrop approximately 50± feet north of boring and boulders observed at ground surface in vicinity of boring. 2) Sampler and auger refusal on probable boulder at approximately 2.7± feet below ground surface (bgs). Offset boring 4± feet northeast then continued boring as B-1A. 3) Switched from solid-stem augers to drive-and-wash drilling methods following S-3 sample. 4) Groundwater not observed prior to introducing water into borehole at 6± feet bgs following S-3 sample. 5) Borehole permeability test performed at approximately 6± feet bgs. 6) Boring terminated upon sampler refusal on possible bedrock at approximately 9.5± feet bgs.	Standard Penetration Resistance	Density	Abbreviations	
	(Blows/Foot)			F = Fine
	0 - 4	Very Loose		M = Medium
	4 - 10	Loose		C = Coarse
	10 - 30	Med. Dense		F/M = Fine to Medium
	30 - 50	Dense		F/C = Fine to Coarse
	50+	Very Dense		Proportions Used
				Trace (T) = 0 - 10%
				Little (Li) = 10 - 20%
				Some (So) = 20 - 35%
			AND = 35-50%	

NORTHEAST GEOTECHNICAL, INC.

TEST BORING LOG	Project: <u>Proposed Residences at Bel Mont</u> <u>Former McLean Hospital Site</u> <u>Belmont, MA</u>	Test Boring No.: <u>B-2/B-2A</u> Page: <u>1 of 1</u> File No.: <u>O432.01</u> Reviewed By: <u>Glenn Olson, P.E.</u>
------------------------	---	--

Boring Co. <u>Soil X Corp.</u>	Date/Weather: <u>6-2-21 to 6-3-21/Clear to Overcast, 60s-70s °F</u>
Foreman: <u>Rich Bonnetti</u>	Northeast Geotechnical Observer: <u>Christian Rice, P.E.</u>
Boring Equipment: <u>Acker AD-II Drill Rig, 2.0" O.D. Split Spoon</u> <u>4¼" I.D. Hollow-Stem Augers/7' then 3" Diam.</u>	Test Boring Location: <u>See Exploration Location Plan</u>
<u>Casing w/ Roller Bit, 140 lb Auto Hammer</u>	Ground Surface Elevation: <u>182± feet</u>
	Depth to Water: <u>See Note 4</u>

Sample Data							Strata Change	Sample Description
No.	Depth	Pen.	Rec.	Blows per 6 in.	Rem.			
5'	S-1A	0-0.5'	6"	6"	30		Top. Fill, 0.5'±	Dark brown, SILT, little (-) F. Gravel, little Roots, trace F/M Sand
	S-1B	0.5-2'	18"	12"	25-24-15	1	Existing Fill	Dense, gray-brown, F/C GRAVEL, some F/C Sand, some (-) Silt, trace (-) Roots
	S-2	2-4'	24"	9"	7-9-11-11			Medium dense, gray-dark brown, SILT and F/M SAND, little (+) F. Gravel
	S-3	4.5-6'	18"	8"	54-29-49	2		5'±
	S-4A	5-5.3'	3"	3"	3		Buried Topsoil, 5.3'±	Loose, dark brown, SILT, trace F. Sand, trace Roots
	S-4B	5.3-7'	21"	13"	18-4-7		Buried Subsoil, 7'±	Medium dense, light brown, SILT, trace F. Sand, trace F. Gravel, trace (-) Roots
	S-5	7-9'	24"	14"	22-29-31-40	3,4	Natural Glacial Till	Very dense, gray, F/C SAND, some F/C Gravel, some Silt
10'	S-6	9.6-9.9'	3"	2"	50/3"	5,6	9.9'±	Very dense, gray-brown, F/C SAND, some F/C Gravel, little Silt
							Refusal	Bottom of boring at 9.9± feet
15'								
20'								
25'								

Notes: 1) Auger grinding on probable cobbles and/or boulders observed from approximately 1± to 4.5± feet below ground surface (bgs). 2) Split spoon sampler observed to be deformed from probable cobbles and/or boulders following extraction. Offset boring approximately 12± feet west then continued boring as B-2A. 3) Switched from hollow-stem augers to drive-and-wash drilling methods following S-5 sample. 4) Groundwater not observed prior to introducing water into borehole at 9± feet bgs following S-5 sample. 5) Borehole permeability test performed at approximately 9.6± feet bgs. 6) Boring terminated upon sampler refusal on possible bedrock at approximately 9.9± feet bgs.	Standard Penetration Resistance	Density	Abbreviations	
	(Blows/Foot)			F = Fine
	0 - 4	Very Loose		M = Medium
	4 - 10	Loose		C = Coarse
	10 - 30	Med. Dense		F/M = Fine to Medium
	30 - 50	Dense		F/C = Fine to Coarse
	50+	Very Dense		Proportions Used
				Trace (T) = 0 - 10%
				Little (Li) = 10 - 20%
				Some (So) = 20 - 35%
			AND = 35-50%	

NORTHEAST GEOTECHNICAL, INC.

TEST BORING LOG

Project: Proposed Residences at Bel Mont
Former McLean Hospital Site
Belmont, MA

Test Boring No.: B-3
 Page: 1 of 1
 File No.: O432.01
 Reviewed By: Glenn Olson, P.E.

Boring Co.: Soil X Corp. Date/Weather: 6-2-2021 / Clear, 60s to 70s °F
 Foreman: Rich Bonnetti Northeast Geotechnical Observer: Christian Rice, P.E.
 Boring Equipment: Acker AD-II Drill Rig, 2.0" O.D. Split Spoon Test Boring Location: See Exploration Location Plan
3" Diam. Casing w/ Roller Bit/5.8' then 3" Diam. Ground Surface Elevation: 169± feet
Solid-Stem Augers, 140 lb Auto Hammer Depth to Water: See Note 2

Sample Data							Strata Change	Sample Description
No.	Depth	Pen.	Rec.	Blows per 6 in.	Rem.			
5'	S-1A	0-0.3'	4"	4"	2		Topsoil, 0.3'±	Very loose, dark brown, SILT, little Roots, trace F. Sand
	S-1B	0.3-2'	20"	11"	10-5-7	1	Subsoil	Med. dense, brown, SILT, little F/C Gravel, trace F. Sand, trace Roots
	S-2A	2-2.3'	4"	4"	4		2.3'±	Loose, light brown, SILT, some F. Sand, trace Roots
	S-2B	2.3-4'	20"	15"	20-32-36	2	Natural Glacial Till	Very dense, gray, F/C SAND, little (+) Silt, little F/C Gravel, trace (-) Roots
S-3	5.8-7.8'	24"	13"	20-40-39-32	3,4	Very dense, gray, F/C SAND, some F/C Gravel, some Silt		
					5			
10'	S-4	10-12'	24"	16"	28-26-27-26		12'±	Very dense, gray-brown, F/C SAND, some Silt, some F/C Gravel
						6		
15'							Bottom of boring at 12± feet	
20'								
25'								

Notes:	Standard Penetration Resistance	Density	Abbreviations	
	1) Resistance while driving casing on probable cobbles and/or boulders observed from approximately 1± to 4± feet below ground surface (bgs). 2) Groundwater not observed prior to introducing water into borehole at 4± feet bgs following S-2 sample. 3) Borehole permeability test performed at approximately 5.8± feet bgs. 4) Switched from drive-and-wash to solid-stem auger drilling methods following S-3 sample. 5) Auger grinding on probable cobbles and/or boulders observed from approximately 7± to 10± feet bgs. 6) Boring terminated at approximately 12± feet bgs.	(Blows/Foot)		F = Fine
		0 - 4	Very Loose	M = Medium
		4 - 10	Loose	C = Coarse
		10 - 30	Med. Dense	F/M = Fine to Medium
		30 - 50	Dense	F/C = Fine to Coarse
		50+	Very Dense	Proportions Used
				Trace (T) = 0 - 10%
				Little (Li) = 10 - 20%
				Some (So) = 20 - 35%
			AND = 35-50%	

NORTHEAST GEOTECHNICAL, INC.

TEST BORING LOG

Project: Proposed Residences at Bel Mont
Former McLean Hospital Site
Belmont, MA

Test Boring No.: B-5
 Page: 1 of 1
 File No.: O432.01
 Reviewed By: Glenn Olson, P.E.

Boring Co.: Soil X Corp. Date/Weather: 6-3-2021 / Overcast, 60s to 70s °F
 Foreman: Rich Bonnetti Northeast Geotechnical Observer: Christian Rice, P.E.
 Boring Equipment: Acker AD-II Drill Rig, 2.0" O.D. Split Spoon Test Boring Location: See Exploration Location Plan
3" Diam. Solid-Stem Augers/4' then 3" Diam. Ground Surface Elevation: 173± feet
Casing w/ Roller Bit, 140 lb Auto Hammer Depth to Water: See Note 3

Sample Data							Strata Change	Sample Description
No.	Depth	Pen.	Rec.	Blows per 6 in.	Rem.			
5'	S-1A	0-0.4'	5"	5"	2		Topsoil, 0.4'±	Very loose, dark brown, SILT, some Roots, trace F. Sand
	S-1B	0.4-1.5'	13"	13"	2-4		Subsoil, 1.5'±	Loose, brown, SILT, trace (+) F. Sand, trace (+) F/C Gravel, trace Roots
	S-1C	1.5-2'	6"	2"	12	1	Natural Glacial Till 6.5'±	Medium dense, gray-brown, F/C SAND, little Silt, little F. Gravel
	S-2	2-4'	24"	15"	14-26-37-50	2,3		Very dense, gray-brown, F/C SAND and F/C GRAVEL, little Silt
	S-3	5-6.5'	18"	8"	27-28-50/6"	4		Very dense, gray, F/C GRAVEL, some (+) F/C Sand, little (-) Silt
10'					5	Refusal	Bottom of boring at 6.5± feet	
15'								
20'								
25'								

Notes:	Standard Penetration Resistance	Density	Abbreviations	
	1) Auger grinding on probable cobbles and/or boulders observed from approximately 2± to 5± feet below ground surface (bgs). 2) Switched from solid-stem augers to drive-and-wash drilling methods following S-2 sample. 3) Groundwater not observed prior to introducing water into borehole at 4± feet bgs following S-2 sample. 4) Borehole permeability test performed at approximately 5± feet bgs. 5) Boring terminated upon sampler and roller bit refusal on possible bedrock at approximately 6.5± feet bgs.	(Blows/Foot)		F = Fine
		0 - 4	Very Loose	M = Medium
		4 - 10	Loose	C = Coarse
		10 - 30	Med. Dense	F/M = Fine to Medium
		30 - 50	Dense	F/C = Fine to Coarse
		50+	Very Dense	Proportions Used
				Trace (T) = 0 - 10%
				Little (Li) = 10 - 20%
				Some (So) = 20 - 35%
			AND = 35-50%	

NORTHEAST GEOTECHNICAL, INC.

TEST BORING LOG

Project: Proposed Residences at Bel Mont
Former McLean Hospital Site
Belmont, MA

Test Boring No.: B-6
 Page: 1 of 1
 File No.: O432.01
 Reviewed By: Glenn Olson, P.E.

Boring Co. Soil X Corp. Date/Weather: 6-4-2021 / Overcast, 60s to 70s °F
 Foreman: Rich Bonnetti Northeast Geotechnical Observer: Christian Rice, P.E.
 Boring Equipment: Acker AD-II Drill Rig, 2.0" O.D. Split Spoon Test Boring Location: See Exploration Location Plan
3" Diam. Solid-Stem Augers/4' then 3" Diam. Ground Surface Elevation: 171± feet
Casing w/ Roller Bit, 140 lb Auto Hammer Depth to Water: See Note 3

Sample Data							Strata Change	Sample Description
No.	Depth	Pen.	Rec.	Blows per 6 in.	Rem.			
5'	S-1A	0-0.7'	8"	8"	3		Topsoil, 0.7'±	Loose, brown, SILT, little Roots, trace F. Sand, trace F. Gravel
	S-1B	0.7-2'	16"	7"	3-3-4		Subsoil, 2'±	Loose, light brown, SILT, little F. Sand, trace F. Gravel, trace Roots
	S-2	2-2.8'	9"	4"	11-50/3"	1	Natural Glacial Till	Very dense, gray-brown, F/C GRAVEL and F/C SAND, some (-) Silt
						2,3		
	S-3	5.1-6'	11"	7"	21-50/5"	4,5	6'±	Very dense, gray-brown, SILT and F/C SAND, some (-) F/C Gravel
10'							Refusal	Bottom of boring at 6± feet
15'								
20'								
25'								

- Notes:
- 1) Sampler refusal at approximately 2.8± feet below ground surface (bgs). Heavy auger grinding observed from approximately 2.8± to 4± feet on probable cobbles and/or boulders.
 - 2) Switched from solid-stem augers to drive-and-wash drilling methods following augering through probable cobbles and/or boulders to 4± feet bgs.
 - 3) Groundwater not observed prior to introducing water into borehole at 4± feet bgs following augering through probable cobbles and/or boulders.
 - 4) Borehole permeability test performed at approximately 5.1± feet bgs.
 - 5) Boring terminated upon sampler and roller bit refusal on possible bedrock at approximately 6± feet bgs.

Standard Penetration Resistance	Density	Abbreviations
(Blows/Foot)		F = Fine
		M = Medium
0 - 4	Very Loose	C = Coarse
4 - 10	Loose	F/M = Fine to Medium
10 - 30	Med. Dense	F/C = Fine to Coarse
30 - 50	Dense	Proportions Used
50+	Very Dense	Trace (T) = 0 - 10%
		Little (Li) = 10 - 20%
		Some (So) = 20 - 35%
		AND = 35-50%

APPENDIX C

Test Pit Logs

NORTHEAST GEOTECHNICAL, INC.

TEST PIT LOG

Project: Proposed Residences at Bel Mont
Former McLean Hospital Site
Belmont, MA

Test Pit/Deep Observation Hole Number: TP-1

Subcontractor: Lussier Corporation
 Operator: Jimmy
 Equipment: Case CX145CSR Excavator
 Capacity/Reach: 1 CY toothed bucket / 20± feet

Date/Weather: 6-1-2021 / Overcast, 50s to 70s °F
 Northeast Geotechnical Observer: Christian Rice, P.E.
 Test Pit Location: See Exploration Location Plan
 Ground Surface Elevation: 194± feet

Page: 1 of 1
 File No.: O432.01
 Reviewed By: Glenn Olson, P.E.

Depth (in.)	Soil Horizon/Layer	Soil Matrix: Color-Moist (Munsell)	Redoximorphic Features (mottles)			Soil Texture (USDA)	Coarse Fragments		Soil Structure	Soil Consistence (Moist)	Other
			Depth (in.)	Color	Percent		Gravel	Cobbles & Stones			
0 - 9±	Topsoil (A _p)	7.5YR/2.5/1	---	---	---	Silt Loam	5%±	5%±	Granular	Very Friable	Frequent roots
9 - 41±	Subsoil (B _w)	10YR/3/6	---	--	---	Silt Loam	5%±	5%±	Granular	Friable	Frequent roots
41 - 100±	Natural Glacial Till (C)	5Y/3/2	64±	10YR/5/6	5±	Loamy Sand	25%±	25%±	Granular	Firm	Trace roots, frequent boulders

Groundwater Observed: No Depth Weeping from Pit: N/A Depth Standing Water in Hole: N/A

Estimated Depth (Elevation) to Seasonal High Groundwater: 64± inches (Elevation 188.7± feet)

- Notes: 1) Test Pit Dimensions: 12± feet (North/South) x 4± feet (East/West)
 2) Test pit terminated upon excavator refusal on apparent bedrock at 100± inches (8.3± feet) below existing grade.

NORTHEAST GEOTECHNICAL, INC.

TEST PIT LOG

Project: Proposed Residences at Bel Mont
Former McLean Hospital Site
Belmont, MA

Test Pit/Deep Observation Hole Number: TP-2

Subcontractor: Lussier Corporation
 Operator: Jimmy
 Equipment: Case CX145CSR Excavator
 Capacity/Reach: 1 CY toothed bucket / 20± feet

Date/Weather: 6-1-2021 / Overcast, 50s to 70s °F
 Northeast Geotechnical Observer: Christian Rice, P.E.
 Test Pit Location: See Exploration Location Plan
 Ground Surface Elevation: 177± feet

Page: 1 of 1
 File No.: O432.01
 Reviewed By: Glenn Olson, P.E.

Depth (in.)	Soil Horizon/Layer	Soil Matrix: Color-Moist (Munsell)	Redoximorphic Features (mottles)			Soil Texture (USDA)	Coarse Fragments		Soil Structure	Soil Consistence (Moist)	Other
			Depth (in.)	Color	Percent		Gravel	Cobbles & Stones			
0 - 45±	Fill	10YR/2/2	---	---	---	Silt Loam	15±%	15±%	Granular	Friable	Trace brick/ashpalt, occasional roots, occasional boulders up to 36± inches
45 - 52±	Buried Topsoil	10YR/2/2	---	---	---	Silt Loam	10±%	0%	Granular	Friable	Frequent roots
52 - 64±	Buried Subsoil	10YR/4/6	---	---	---	Silt Loam	5±%	0%	Granular	Friable	Occasional roots
64 - 120±	Natural Glacial Till (C)	5Y/3/2	87±	10YR/5/8	5±	Sandy Loam	20±%	15±%	Granular	Firm	Trace roots, occasional boulders up to 18± inches

Groundwater Observed: No Depth Weeping from Pit: N/A Depth Standing Water in Hole: N/A

Estimated Depth (Elevation) to Seasonal High Groundwater: 87± inches (Elevation 169.8± feet)

- Notes: 1) Test Pit Dimensions: 4± feet (North/South) x 12± feet (East/West)
 2) Test pit terminated upon excavator refusal on apparent bedrock at 120± inches (10± feet) below existing grade.

NORTHEAST GEOTECHNICAL, INC.

TEST PIT LOG

Project: Proposed Residences at Bel Mont
Former McLean Hospital Site
Belmont, MA

Test Pit/Deep Observation Hole Number: TP-3

Subcontractor: Lussier Corporation
 Operator: Jimmy
 Equipment: Case CX145CSR Excavator
 Capacity/Reach: 1 CY toothed bucket / 20± feet

Date/Weather: 6-2-2021 / Clear, 60s to 70s °F
 Northeast Geotechnical Observer: Christian Rice, P.E.
 Test Pit Location: See Exploration Location Plan
 Ground Surface Elevation: 167± feet

Page: 1 of 1
 File No.: O432.01
 Reviewed By: Glenn Olson, P.E.

Depth (in.)	Soil Horizon/Layer	Soil Matrix: Color-Moist (Munsell)	Redoximorphic Features (mottles)			Soil Texture (USDA)	Coarse Fragments		Soil Structure	Soil Consistence (Moist)	Other
			Depth (in.)	Color	Percent		Gravel	Cobbles & Stones			
0 - 10±	Topsoil (A _p)	10YR/2/2	---	---	---	Sandy Loam	5±%	0%	Granular	Very Friable	Frequent roots, boulders observed at ground surface
10 - 28±	Subsoil (B _w)	10YR/4/4	---	---	---	Sandy Loam	10±%	10±%	Granular	Friable	Frequent roots
28 - 94±	Natural Glacial Till (C)	5Y/4/2	---	---	---	Sandy Loam	25±%	15±%	Granular	Firm	Trace roots, occasional boulders up to 48± inches

Groundwater Observed: No Depth Weeping from Pit: N/A Depth Standing Water in Hole: N/A

Estimated Depth (Elevation) to Seasonal High Groundwater: N/A

- Notes: 1) Test Pit Dimensions: 12± feet (North/South) x 4± feet (East/West)
 2) Test pit terminated upon excavator refusal on apparent bedrock at 94± inches (7.8± feet) below existing grade.

NORTHEAST GEOTECHNICAL, INC.

TEST PIT LOG

Project: Proposed Residences at Bel Mont
Former McLean Hospital Site
Belmont, MA

Test Pit/Deep Observation Hole Number: TP-4

Subcontractor: Lussier Corporation
 Operator: Jimmy
 Equipment: Case CX145CSR Excavator
 Capacity/Reach: 1 CY toothed bucket / 20± feet

Date/Weather: 6-1-2021 / Overcast, 50s to 70s °F
 Northeast Geotechnical Observer: Christian Rice, P.E.
 Test Pit Location: See Exploration Location Plan
 Ground Surface Elevation: 172± feet

Page: 1 of 1
 File No.: O432.01
 Reviewed By: Glenn Olson, P.E.

Depth (in.)	Soil Horizon/Layer	Soil Matrix: Color-Moist (Munsell)	Redoximorphic Features (mottles)			Soil Texture (USDA)	Coarse Fragments		Soil Structure	Soil Consistence (Moist)	Other
			Depth (in.)	Color	Percent		Gravel	Cobbles & Stones			
0 - 8±	Topsoil (A _p)	10YR/2/1	---	---	---	Loam	5±%	5±%	Granular	Very Friable	Frequent roots
8 - 21±	Subsoil (B _w)	10YR/3/4	---	---	---	Sandy Loam	15±%	10±%	Granular	Friable	Frequent roots
21 - 81±	Natural Glacial Till (C)	5Y/4/2	71±	10YR/4/6	5±	Loamy Sand	30±%	20±%	Granular	Firm	Trace roots, frequent boulders up to 36± inches

Groundwater Observed: No Depth Weeping from Pit: N/A Depth Standing Water in Hole: N/A

Estimated Depth (Elevation) to Seasonal High Groundwater: 71± inches (Elevation 166.1± feet)

- Notes: 1) Test Pit Dimensions: 4± feet (North/South) x 14± feet (East/West)
 2) Test pit terminated upon excavator refusal on apparent bedrock at 81± inches (6.8± feet) below existing grade.

NORTHEAST GEOTECHNICAL, INC.

TEST PIT LOG

Project: Proposed Residences at Bel Mont
Former McLean Hospital Site
Belmont, MA

Test Pit/Deep Observation Hole Number: TP-5

Subcontractor: Lussier Corporation
 Operator: Jimmy
 Equipment: Case CX145CSR Excavator
 Capacity/Reach: 1 CY toothed bucket / 20± feet

Date/Weather: 6-1-2021 / Overcast, 50s to 70s °F
 Northeast Geotechnical Observer: Christian Rice, P.E.
 Test Pit Location: See Exploration Location Plan
 Ground Surface Elevation: 166± feet

Page: 1 of 1
 File No.: O432.01
 Reviewed By: Glenn Olson, P.E.

Depth (in.)	Soil Horizon/Layer	Soil Matrix: Color-Moist (Munsell)	Redoximorphic Features (mottles)			Soil Texture (USDA)	Coarse Fragments		Soil Structure	Soil Consistence (Moist)	Other
			Depth (in.)	Color	Percent		Gravel	Cobbles & Stones			
0 - 7±	Topsoil (A _p)	7.5YR/2/1	---	---	---	Loam	5±%	0%	Granular	Friable	Frequent roots
7 - 22±	Subsoil (B _w)	10YR/4/6	---	---	---	Sandy Loam	5±%	5±%	Granular	Friable	Frequent roots
22 - 96±	Natural Glacial Till (C)	5Y/3/2	---	---	---	Loamy Sand	30±%	15±%	Granular	Firm	Trace roots, frequent boulders up to 18"

Groundwater Observed: No Depth Weeping from Pit: N/A Depth Standing Water in Hole: N/A

Estimated Depth (Elevation) to Seasonal High Groundwater: N/A

- Notes: 1) Test Pit Dimensions: 14± feet (North/South) x 4± feet (East/West)
 2) Test pit terminated upon excavator refusal on apparent bedrock at 96± inches (8± feet) below existing grade.

NORTHEAST GEOTECHNICAL, INC.

TEST PIT LOG

Project: Proposed Residences at Bel Mont
Former McLean Hospital Site
Belmont, MA

Test Pit/Deep Observation Hole Number: TP-6

Subcontractor: Lussier Corporation
 Operator: Jimmy
 Equipment: Case CX145CSR Excavator
 Capacity/Reach: 1 CY toothed bucket / 20± feet

Date/Weather: 6-1-2021 / Overcast, 50s to 70s °F
 Northeast Geotechnical Observer: Christian Rice, P.E.
 Test Pit Location: See Exploration Location Plan
 Ground Surface Elevation: 167± feet

Page: 1 of 1
 File No.: O432.01
 Reviewed By: Glenn Olson, P.E.

Depth (in.)	Soil Horizon/Layer	Soil Matrix: Color-Moist (Munsell)	Redoximorphic Features (mottles)			Soil Texture (USDA)	Coarse Fragments		Soil Structure	Soil Consistence (Moist)	Other
			Depth (in.)	Color	Percent		Gravel	Cobbles & Stones			
0 - 6±	Topsoil (A _p)	7.5YR/2.5/3	---	---	---	Sandy Loam	5±%	0%	Granular	Friable	Frequent roots
6 - 25±	Subsoil (B _w)	10YR/3/6	---	---	---	Sandy Loam	15±%	30±%	Granular	Friable	Frequent roots
25 - 48±	Natural Glacial Till (C)	2.5Y/4/2	---	---	---	Loamy Sand	40±%	30±%	Granular	Firm	Trace roots, frequent boulders or fractured bedrock pieces

Groundwater Observed: No Depth Weeping from Pit: N/A Depth Standing Water in Hole: N/A

Estimated Depth (Elevation) to Seasonal High Groundwater: N/A

- Notes: 1) Test Pit Dimensions: 4± feet (North/South) x 12± feet (East/West)
 2) Test pit terminated upon excavator refusal on apparent bedrock at 48± inches (4± feet) below existing grade.

NORTHEAST GEOTECHNICAL, INC.

TEST PIT LOG

Project: Proposed Residences at Bel Mont
Former McLean Hospital Site
Belmont, MA

Test Pit/Deep Observation Hole Number: TP-7

Subcontractor: Lussier Corporation
 Operator: Jimmy
 Equipment: Case CX145CSR Excavator
 Capacity/Reach: 1 CY toothed bucket / 20± feet

Date/Weather: 6-1-2021 / Overcast, 50s to 70s °F
 Northeast Geotechnical Observer: Christian Rice, P.E.
 Test Pit Location: See Exploration Location Plan
 Ground Surface Elevation: 180± feet

Page: 1 of 1
 File No.: O432.01
 Reviewed By: Glenn Olson, P.E.

Depth (in.)	Soil Horizon/Layer	Soil Matrix: Color-Moist (Munsell)	Redoximorphic Features (mottles)			Soil Texture (USDA)	Coarse Fragments		Soil Structure	Soil Consistence (Moist)	Other
			Depth (in.)	Color	Percent		Gravel	Cobbles & Stones			
0 -7±	Topsoil Fill	10YR/3/1	---	---	---	Sandy Loam	5±%	0%	Granular	Friable	Frequent roots
7 - 20±	Granular Fill	2.5Y/3/2	---	---	---	Loamy Sand	40±%	20±%	Granular	Firm	Trace brick
20 - 33±	Fractured Bedrock (R)	5Y/3/1	---	---	---	Loamy Sand	20±%	60±%	Granular	Firm	Gravel, cobbles & stone percentages are pieces of bedrock

Groundwater Observed: Yes (perched) Depth Weeping from Pit: 19" Depth Standing Water in Hole: N/A

Estimated Depth (Elevation) to Seasonal High Groundwater: 19± inches (Elevation 178.4± feet)

- Notes: 1) Test Pit Dimensions: 4± feet (North/South) x 12± feet (East/West)
 2) Test pit terminated upon excavator refusal on apparent bedrock at 33± inches (2.8± feet) below existing grade.

NORTHEAST GEOTECHNICAL, INC.

TEST PIT LOG

Project: Proposed Residences at Bel Mont
Former McLean Hospital Site
Belmont, MA

Test Pit/Deep Observation Hole Number: TP-8

Subcontractor: Lussier Corporation
 Operator: Jimmy
 Equipment: Case CX145CSR Excavator
 Capacity/Reach: 1 CY toothed bucket / 20± feet

Date/Weather: 6-1-2021 / Overcast, 50s to 70s °F
 Northeast Geotechnical Observer: Christian Rice, P.E.
 Test Pit Location: See Exploration Location Plan
 Ground Surface Elevation: 187.5± feet

Page: 1 of 1
 File No.: O432.01
 Reviewed By: Glenn Olson, P.E.

Depth (in.)	Soil Horizon/Layer	Soil Matrix: Color-Moist (Munsell)	Redoximorphic Features (mottles)			Soil Texture (USDA)	Coarse Fragments		Soil Structure	Soil Consistence (Moist)	Other
			Depth (in.)	Color	Percent		Gravel	Cobbles & Stones			
0 - 7±	Topsoil (A _p)	7.5YR/2.5/2	---	---	---	Sandy Loam	5±%	0%	Granular	Friable	Frequent roots
7 - 24±	Subsoil (B _w)	7.5YR/4/4	---	---	---	Sandy Loam	10±%	5±%	Granular	Friable	Frequent roots
24 - 43±	Natural Glacial Till (C)	2.5Y/4/1	---	---	---	Loamy Sand	30±%	15±%	Granular	Firm	Trace roots, occasional boulders up to 24± inches

Groundwater Observed: No Depth Weeping from Pit: N/A Depth Standing Water in Hole: N/A

Estimated Depth (Elevation) to Seasonal High Groundwater: N/A

- Notes: 1) Test Pit Dimensions: 4± feet (North/South) x 12± feet (East/West)
 2) Test pit terminated upon excavator refusal on apparent bedrock at 43± inches (3.6± feet) below existing grade.

APPENDIX D

Test Pit Photos

NORTHEAST GEOTECHNICAL, INC.



Photograph #1

Description of Photograph:

Test Pit TP-1

Photograph Taken By:

Christian Rice dated 6-2-21



Photograph #2

Description of Photograph:

Test Pit TP-2

Photograph Taken By:

Christian Rice dated 6-2-21

NORTHEAST GEOTECHNICAL, INC.



Photograph #3

Description of Photograph:

Test Pit TP-3

Photograph Taken By:

Christian Rice dated 6-3-21



Photograph #4

Description of Photograph:

Test Pit TP-4

Photograph Taken By:

Christian Rice dated 6-2-21

NORTHEAST GEOTECHNICAL, INC.



Photograph #5

Description of Photograph:

Test Pit TP-5

Photograph Taken By:

Christian Rice dated 6-2-21



Photograph #6

Description of Photograph:

Test Pit TP-6

Photograph Taken By:

Christian Rice dated 6-2-21

NORTHEAST GEOTECHNICAL, INC.



Photograph #7

Description of Photograph:

Test Pit TP-7

Photograph Taken By:

Christian Rice dated 6-2-21



Photograph #8

Description of Photograph:

Test Pit TP-8

Photograph Taken By:

Christian Rice dated 6-2-21

APPENDIX E

Laboratory Test Results



195 Frances Avenue
 Cranston RI, 02910
 Phone: (401)-467-6454
 Fax: (401)-467-2398
thielsch.com
Let's Build a Solid Foundation

Client Information:
 Northeast Geotechnical, Inc.
 North Attleborough, MA
 PM: Glenn A. Olson, P.E.
 Assigned By: Christian Rice, P.E.
 Collected By: Christian Rice, P.E.

Project Information:
**Proposed Residences at Bel Mont
 Belmont, MA**
 NEG Project Number: O432.01
 Summary Page: 1 of 1
 Report Date: 06.17.21

LABORATORY TESTING DATA SHEET, Report No.: 7421-F-119

Source	Sample No.	Depth (Ft)	Laboratory No.	Identification Tests								Proctor / CBR / Permeability Tests							Laboratory Log and Soil Description	
				As Received Water Content %	LL %	PL %	Gravel %	Sand %	Fines %	Org. %	G _s	Dry unit wt. pcf	Test Water Content %	γ_d MAX (pcf) / γ_d W _{opt} (%)	γ_d MAX (pcf) / γ_d W _{opt} (%) (Corr.)	Target Test Setup as % of Proctor	CBR @ 0.1"	CBR @ 0.2"		Permeability cm/sec
				D2216	D4318		D6913			D2974	D854			D1557						
TP-1	Bulk Sample	3.4-7	21-S-2110				34.9	50.3	14.8											Brown silty sand with gravel
TP-2	Bulk Sample	8-10	21-S-2111				29.2	50.6	20.2											Brown silty sand with gravel
TP-3	Bulk Sample	2.3-7.8	21-S-2112				15.0	61.3	23.7											Brown silty sand with gravel
TP-4	Bulk Sample	1.8-6.8	21-S-2113				29.8	52.4	17.8											Brown silty sand with gravel
TP-5	Bulk Sample	5-8	21-S-2114				36.3	52.5	11.2											Brown poorly graded sand with silt and gravel
TP-6	Bulk Sample	3-4	21-S-2115				48.3	42.3	9.4											Brown poorly graded sand with silt and gravel
B-1	S-4	6-8	21-S-2116				19.6	55.0	25.4											Gray silty sand with gravel
B-2	S-5	7-9	21-S-2117				29.0	46.0	25.0											Gray silty sand with gravel
B-3	S-3	5.8-7.8	21-S-2118				31.8	40.1	28.1											Gray silty sand with gravel

Date Received: 06.03.21

Reviewed By: *SKW*

Date Reviewed: 06.17.21

Particle Size Distribution Report

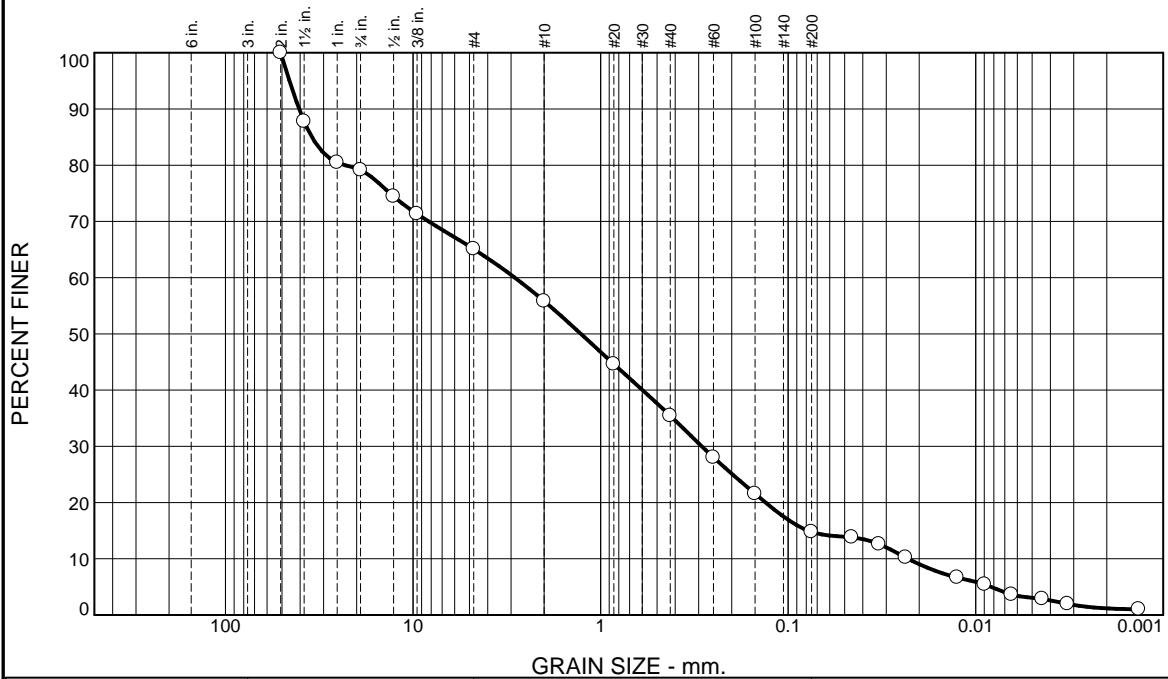

% +3"	% Gravel		% Sand			% Fines	
	Coarse	Fine	Coarse	Medium	Fine	Silt	Clay
0.0	20.9	14.0	9.3	20.4	20.6	13.6	1.2

Test Results (D6913 & ASTM D 1140)			
Opening Size	Percent Finer	Spec.* (Percent)	Pass? (X=Fail)
2"	100.0		
1.5"	87.8		
1"	80.5		
0.75"	79.1		
0.5"	74.4		
0.375"	71.3		
#4	65.1		
#10	55.8		
#20	44.6		
#40	35.4		
#60	28.0		
#100	21.6		
#200	14.8		
0.0458 mm.	13.8		
0.0327 mm.	12.6		
0.0236 mm.	10.2		
0.0125 mm.	6.7		
0.0090 mm.	5.4		
0.0064 mm.	3.6		
0.0044 mm.	2.9		
0.0032 mm.	2.0		
0.0013 mm.	1.0		

* (no specification provided)

Material Description

Brown silty sand with gravel

Atterberg Limits (ASTM D 4318)

PL= NP LL= NV PI= NP

Classification

USCS (D 2487)= SM AASHTO (M 145)= A-1-b

Coefficients

D₉₀= 40.5081 D₈₅= 34.6163 D₆₀= 2.8676
D₅₀= 1.2723 D₃₀= 0.2886 D₁₅= 0.0782
D₁₀= 0.0229 C_u= 125.00 C_c= 1.27

Remarks

Date Received: 06.03.21 Date Tested: 06.07.21

Tested By: AV / SF

Checked By: Steven Accetta

Title: Laboratory Coordinator

Source of Sample: Test Pit Depth: 3.4-7'
Sample Number: TP-1

Date Sampled:

Thielsch Engineering Inc. Cranston, RI	Client: Northeast Geotechnical, Inc. Project: Proposed Residences at Bel Mont Belmont, MA Project No: O432.01
Figure 21-S-2110	

Particle Size Distribution Report

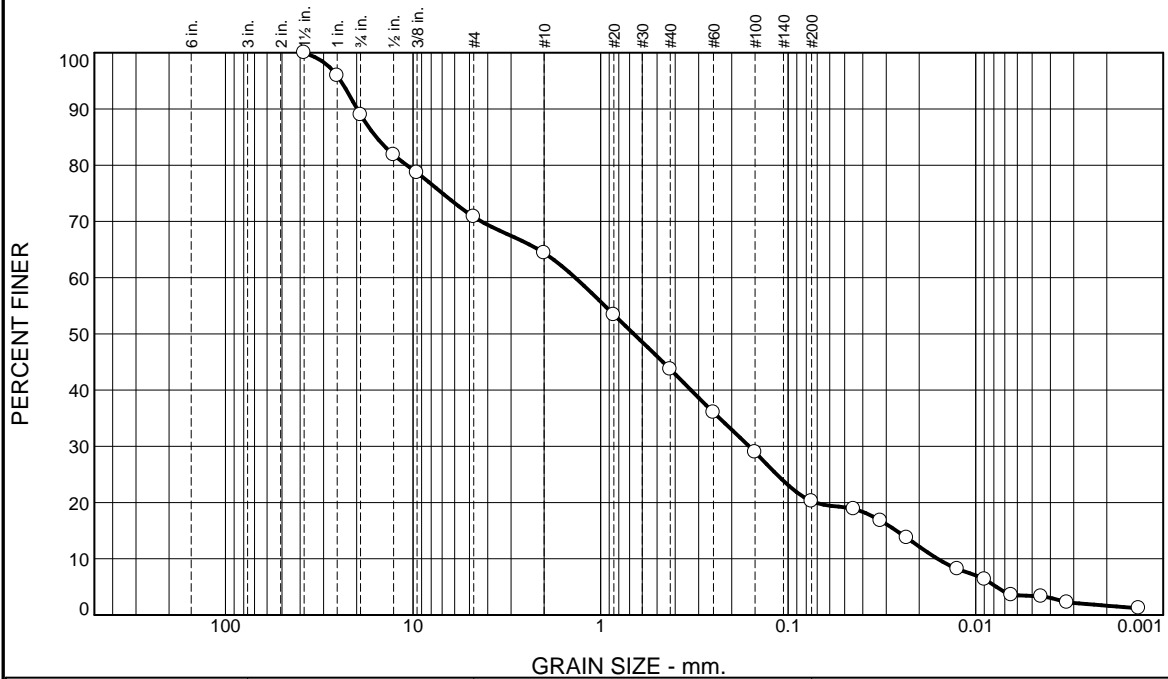

% +3"	% Gravel		% Sand			% Fines	
	Coarse	Fine	Coarse	Medium	Fine	Silt	Clay
0.0	11.0	18.2	6.4	20.7	23.5	18.5	1.7

Test Results (D6913 & ASTM D 1140)			
Opening Size	Percent Finer	Spec.* (Percent)	Pass? (X=Fail)
1.5"	100.0		
1"	95.9		
0.75"	89.0		
0.5"	81.8		
0.375"	78.7		
#4	70.8		
#10	64.4		
#20	53.4		
#40	43.7		
#60	36.0		
#100	29.0		
#200	20.2		
0.0448 mm.	18.9		
0.0322 mm.	16.8		
0.0233 mm.	13.7		
0.0125 mm.	8.2		
0.0090 mm.	6.3		
0.0065 mm.	3.6		
0.0045 mm.	3.3		
0.0033 mm.	2.2		
0.0013 mm.	1.2		

* (no specification provided)

Material Description

Brown silty sand with gravel

Atterberg Limits (ASTM D 4318)

PL= NP LL= NV PI= NP

Classification

USCS (D 2487)= SM AASHTO (M 145)= A-1-b

Coefficients

D₉₀= 19.8599 D₈₅= 15.7083 D₆₀= 1.3643
D₅₀= 0.6660 D₃₀= 0.1613 D₁₅= 0.0265
D₁₀= 0.0160 C_u= 85.46 C_c= 1.20

Remarks

Date Received: 06.03.21 Date Tested: 06.07.21

Tested By: AV / SF

Checked By: Steven Accetta

Title: Laboratory Coordinator

Source of Sample: Test Pit Depth: 8-10'
Sample Number: TP-2

Date Sampled:

Thielsch Engineering Inc. Cranston, RI	Client: Northeast Geotechnical, Inc. Project: Proposed Residences at Bel Mont Belmont, MA Project No: O432.01
Figure 21-S-2111	

Particle Size Distribution Report

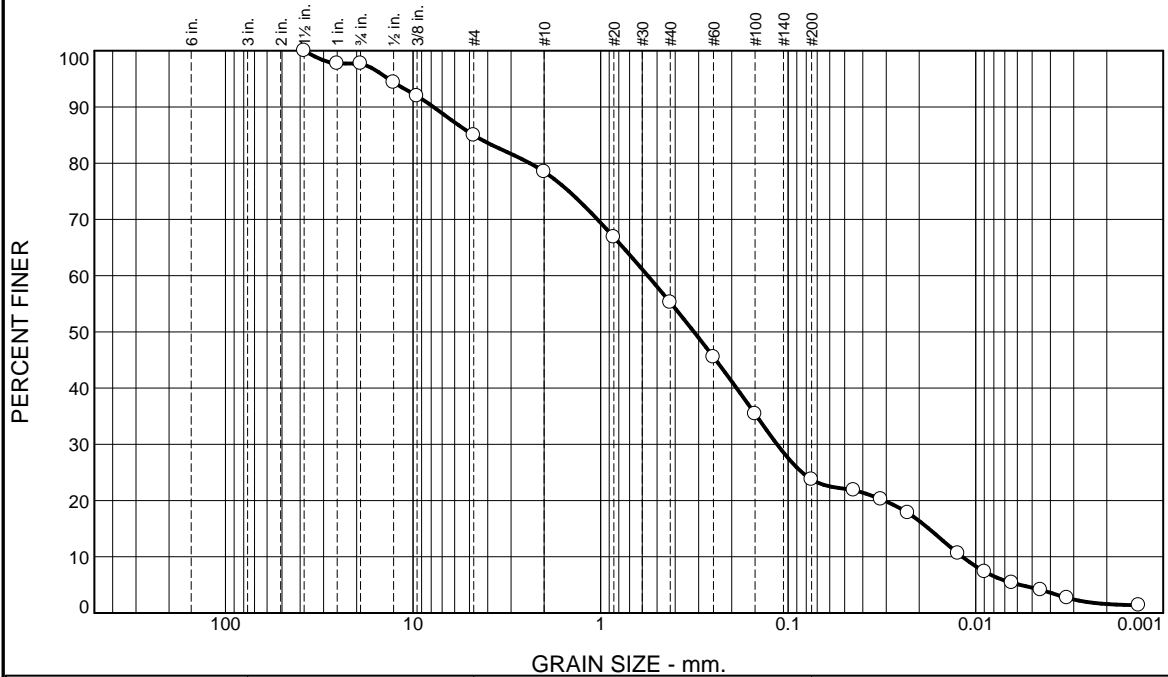

% +3"	% Gravel		% Sand			% Fines	
	Coarse	Fine	Coarse	Medium	Fine	Silt	Clay
0.0	2.3	12.7	6.5	23.3	31.5	22.1	1.6

Test Results (D6913 & ASTM D 1140)			
Opening Size	Percent Finer	Spec.* (Percent)	Pass? (X=Fail)
1.5"	100.0		
1"	97.7		
0.75"	97.7		
0.5"	94.4		
0.375"	92.0		
#4	85.0		
#10	78.5		
#20	66.8		
#40	55.2		
#60	45.5		
#100	35.4		
#200	23.7		
0.0448 mm.	21.8		
0.0320 mm.	20.2		
0.0230 mm.	17.8		
0.0124 mm.	10.6		
0.0090 mm.	7.3		
0.0064 mm.	5.4		
0.0045 mm.	4.1		
0.0033 mm.	2.7		
0.0014 mm.	1.4		

* (no specification provided)

Material Description

Brown silty sand with gravel

Atterberg Limits (ASTM D 4318)

PL= NP LL= NV PI= NP

Classification

USCS (D 2487)= SM AASHTO (M 145)= A-2-4(0)

Coefficients

D₉₀= 7.7724 D₈₅= 4.7588 D₆₀= 0.5606
D₅₀= 0.3176 D₃₀= 0.1146 D₁₅= 0.0178
D₁₀= 0.0118 C_u= 47.60 C_c= 1.99

Remarks

Date Received: 06.03.21 Date Tested: 06.07.21

Tested By: AV / SF

Checked By: Steven Accetta

Title: Laboratory Coordinator

Source of Sample: Test Pit Depth: 3-7.8'
Sample Number: TP-3

Date Sampled:

Thielsch Engineering Inc. Cranston, RI	Client: Northeast Geotechnical, Inc. Project: Proposed Residences at Bel Mont Belmont, MA Project No: O432.01
Figure 21-S-2112	

Particle Size Distribution Report

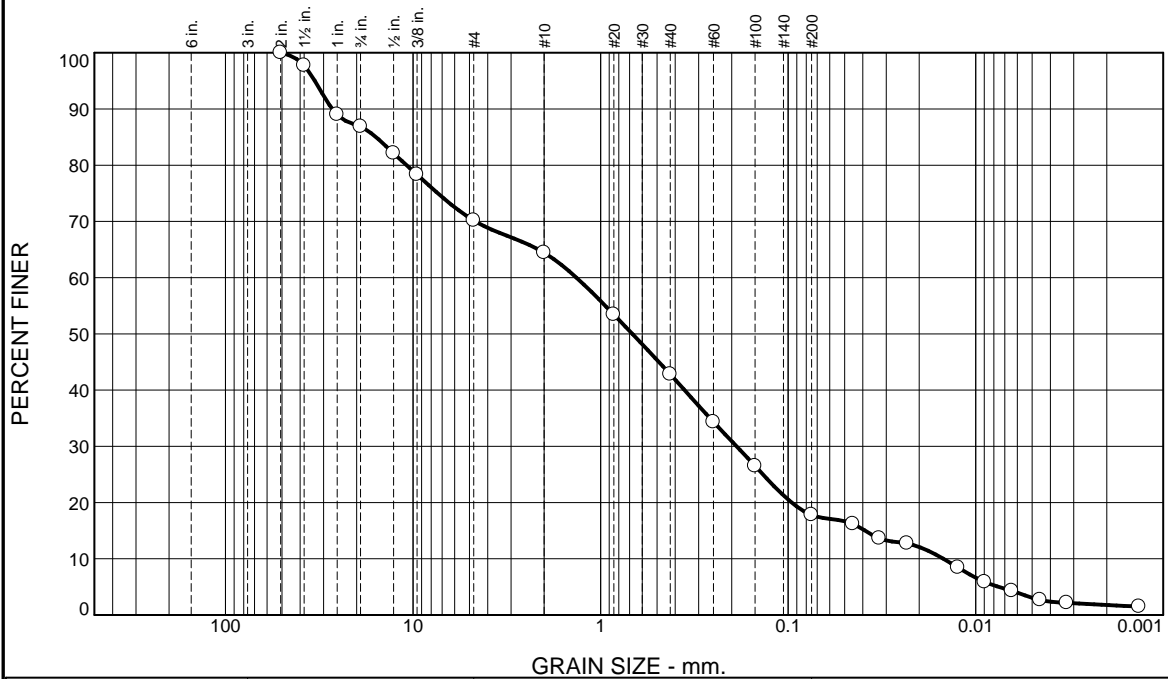

% +3"	% Gravel		% Sand			% Fines	
	Coarse	Fine	Coarse	Medium	Fine	Silt	Clay
0.0	13.1	16.7	5.8	21.6	25.0	16.0	1.8

Test Results (D6913 & ASTM D 1140)			
Opening Size	Percent Finer	Spec.* (Percent)	Pass? (X=Fail)
2"	100.0		
1.5"	97.7		
1"	89.0		
0.75"	86.9		
0.5"	82.1		
0.375"	78.3		
#4	70.2		
#10	64.4		
#20	53.4		
#40	42.8		
#60	34.3		
#100	26.5		
#200	17.8		
0.0452 mm.	16.2		
0.0327 mm.	13.6		
0.0233 mm.	12.7		
0.0124 mm.	8.4		
0.0090 mm.	5.9		
0.0064 mm.	4.3		
0.0045 mm.	2.7		
0.0033 mm.	2.2		
0.0013 mm.	1.5		

* (no specification provided)

Material Description

Brown silty sand with gravel

Atterberg Limits (ASTM D 4318)

PL= NP LL= NV PI= NP

Classification

USCS (D 2487)= SM AASHTO (M 145)= A-1-b

Coefficients

D₉₀= 26.9394 D₈₅= 15.7602 D₆₀= 1.3442
D₅₀= 0.6773 D₃₀= 0.1883 D₁₅= 0.0389
D₁₀= 0.0149 C_u= 90.40 C_c= 1.77

Remarks

Date Received: 06.04.21 Date Tested: 06.09.21

Tested By: AV / SF / MS

Checked By: Steven Accetta

Title: Laboratory Coordinator

Source of Sample: Test Pit Depth: 1.8-6.8'
Sample Number: TP-4

Date Sampled:

Thielsch Engineering Inc. Cranston, RI	Client: Northeast Geotechnical, Inc. Project: Proposed Residences at Bel Mont Belmont, MA Project No: O432.01
Figure 21-S-2113	

Particle Size Distribution Report

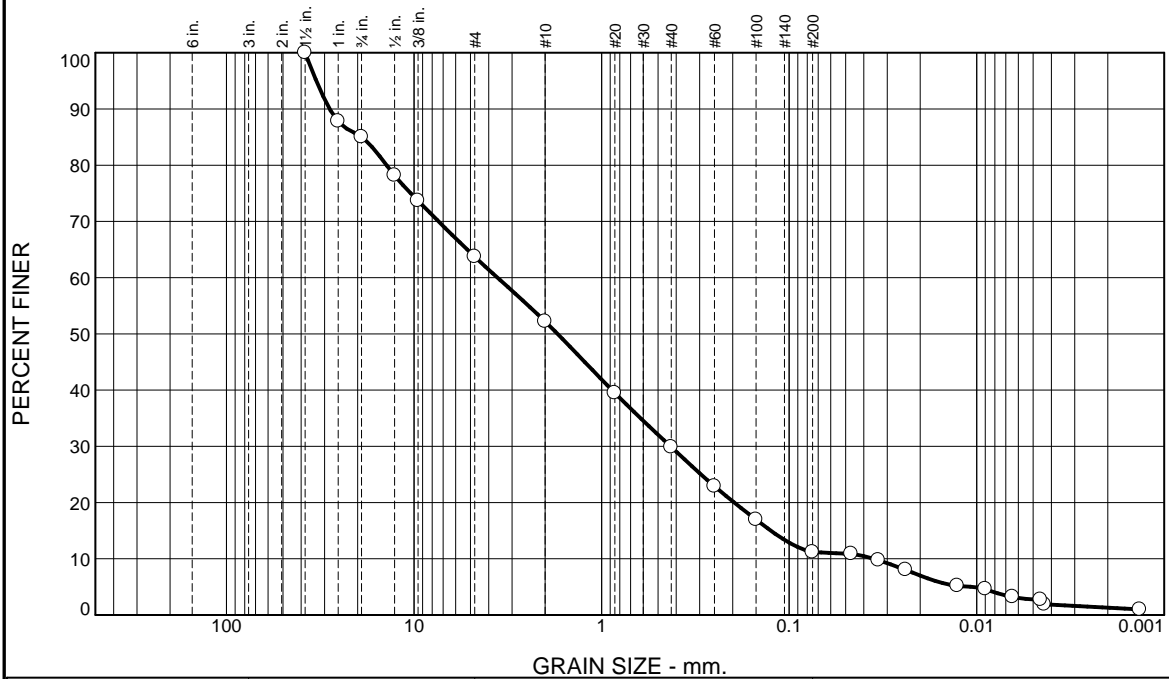

% +3"	% Gravel		% Sand			% Fines	
	Coarse	Fine	Coarse	Medium	Fine	Silt	Clay
0.0	15.0	21.3	11.5	22.3	18.7	9.9	1.3

Test Results (D6913 & ASTM D 1140)			
Opening Size	Percent Finer	Spec.* (Percent)	Pass? (X=Fail)
1.5"	100.0		
1"	87.8		
0.75"	85.0		
0.5"	78.2		
0.375"	73.7		
#4	63.7		
#10	52.2		
#20	39.5		
#40	29.9		
#60	22.9		
#100	17.0		
#200	11.2		
0.0467 mm.	10.9		
0.0334 mm.	9.7		
0.0240 mm.	8.0		
0.0127 mm.	5.2		
0.0090 mm.	4.6		
0.0064 mm.	3.2		
0.0046 mm.	2.7		
0.0044 mm.	1.9		
0.0014 mm.	1.0		

* (no specification provided)

Material Description

Brown poorly graded sand with silt and gravel

Atterberg Limits (ASTM D 4318)

PL= NP LL= NV PI= NP

Classification

USCS (D 2487)= SW-SM AASHTO (M 145)= A-1-b

Coefficients

D₉₀= 28.1626 D₈₅= 19.0268 D₆₀= 3.5875
D₅₀= 1.7172 D₃₀= 0.4291 D₁₅= 0.1252
D₁₀= 0.0354 C_u= 101.30 C_c= 1.45

Remarks

Date Received: 06.03.21 Date Tested: 06.07.21

Tested By: AV / SF

Checked By: Steven Accetta

Title: Laboratory Coordinator

Source of Sample: Test Pit Depth: 5-8'
Sample Number: TP-5

Date Sampled:

Thielsch Engineering Inc.

Cranston, RI

Client: Northeast Geotechnical, Inc.
Project: Proposed Residences at Bel Mont
Belmont, MA
Project No: O432.01

Figure 21-S-2114

Particle Size Distribution Report

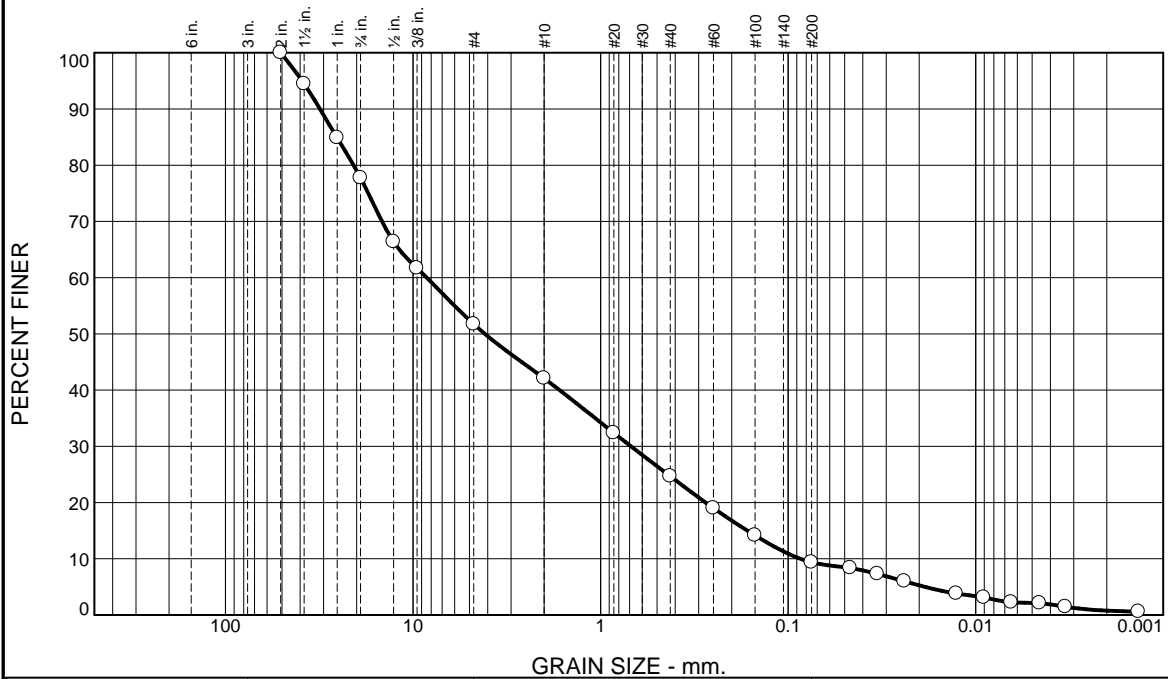

% +3"	% Gravel		% Sand			% Fines	
	Coarse	Fine	Coarse	Medium	Fine	Silt	Clay
0.0	22.3	26.0	9.6	17.4	15.3	8.6	0.8

Test Results (D6913 & ASTM D 1140)			
Opening Size	Percent Finer	Spec.* (Percent)	Pass? (X=Fail)
2"	100.0		
1.5"	94.5		
1"	84.9		
0.75"	77.7		
0.5"	66.4		
0.375"	61.7		
#4	51.7		
#10	42.1		
#20	32.4		
#40	24.7		
#60	19.0		
#100	14.2		
#200	9.4		
0.0467 mm.	8.4		
0.0334 mm.	7.3		
0.0240 mm.	6.0		
0.0127 mm.	3.8		
0.0090 mm.	3.1		
0.0065 mm.	2.2		
0.0046 mm.	2.1		
0.0033 mm.	1.5		
0.0014 mm.	0.6		

* (no specification provided)

Material Description

Brown poorly graded gravel with silt and sand

Atterberg Limits (ASTM D 4318)

PL= NP LL= NV PI= NP

Classification

USCS (D 2487)= GP-GM AASHTO (M 145)= A-1-a

Coefficients

D₉₀= 31.3357 D₈₅= 25.5177 D₆₀= 8.4448
D₅₀= 4.1374 D₃₀= 0.6881 D₁₅= 0.1647
D₁₀= 0.0861 C_u= 98.11 C_c= 0.65

Remarks

Date Received: 06.03.21 Date Tested: 06.09.21

Tested By: AV / SF / MS

Checked By: Steven Accetta

Title: Laboratory Coordinator

Source of Sample: Test Pit Depth: 3-4'
Sample Number: TP-6

Date Sampled:

Thielsch Engineering Inc.	Client: Northeast Geotechnical, Inc.
Cranston, RI	Project: Proposed Residences at Bel Mont Belmont, MA
	Project No: O432.01 Figure 21-S-2115

USDA Soil Classification

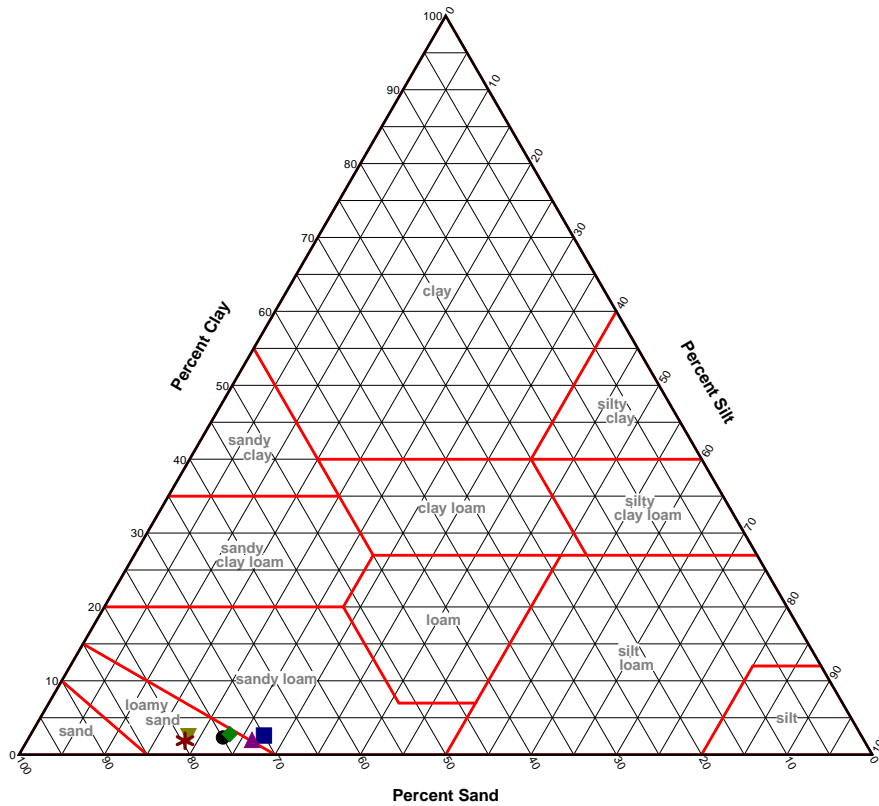

SOIL DATA

	Source	Sample No.	Depth	Percentages From Material Passing a #10 Sieve			Classification
				Sand	Silt	Clay	
●	Test Pit	TP-1	3.4-7'	74.9	22.9	2.2	Loamy sand
■	Test Pit	TP-2	8-10'	70.0	27.3	2.6	Sandy loam
▲	Test Pit	TP-3	3-7.8'	71.7	26.2	2.0	Sandy loam
◆	Test Pit	TP-4	1.8-6.8'	73.9	23.3	2.8	Loamy sand
▼	Test Pit	TP-5	5-8'	78.9	18.6	2.5	Loamy sand
*	Test Pit	TP-6	3-4'	79.6	18.5	1.9	Loamy sand

Thielsch Engineering Inc.
Cranston, RI

Client: Northeast Geotechnical, Inc.
Project: Proposed Residences at Bel Mont
Belmont, MA
Project No.: O432.01

Figure 2110 to 2115

Checked By: sa

Particle Size Distribution Report

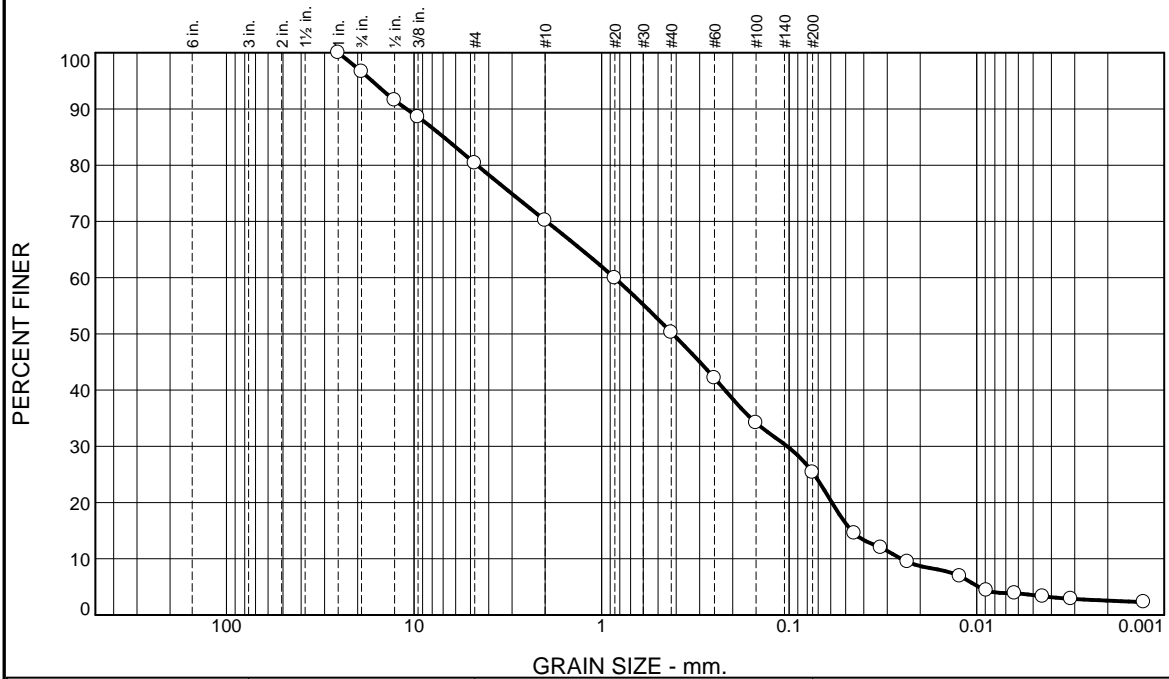

% +3"	% Gravel		% Sand			% Fines	
	Coarse	Fine	Coarse	Medium	Fine	Silt	Clay
0.0	3.4	16.2	10.2	19.9	24.9	22.8	2.6

Test Results (D7928 & ASTM D 1140)			
Opening Size	Percent Finer	Spec.* (Percent)	Pass? (X=Fail)
1"	100.0		
0.75"	96.6		
0.5"	91.6		
0.375"	88.6		
#4	80.4		
#10	70.2		
#20	59.9		
#40	50.3		
#60	42.1		
#100	34.2		
#200	25.4		
0.0449 mm.	14.5		
0.0324 mm.	12.0		
0.0234 mm.	9.5		
0.0123 mm.	6.9		
0.0089 mm.	4.4		
0.0063 mm.	3.9		
0.0044 mm.	3.3		
0.0031 mm.	2.9		
0.0013 mm.	2.3		

* (no specification provided)

Material Description

Gray silty sand with gravel

Atterberg Limits (ASTM D 4318)

PL= NP LL= NV PI= NP

Classification

USCS (D 2487)= SM AASHTO (M 145)= A-1-b

Coefficients

D₉₀= 10.9655 D₈₅= 6.9471 D₆₀= 0.8555
D₅₀= 0.4175 D₃₀= 0.1024 D₁₅= 0.0464
D₁₀= 0.0253 C_u= 33.86 C_c= 0.49

Remarks

Date Received: 06.03.21 Date Tested: 06.09.21

Tested By: JM / MS

Checked By: Steven Accetta

Title: Laboratory Coordinator

Source of Sample: Boring Depth: 6-8'
Sample Number: B-1 / S-4

Date Sampled:

Thielsch Engineering Inc. Cranston, RI	Client: Northeast Geotechnical, Inc. Project: Proposed Residences at Bel Mont Belmont, MA Project No: O432.01
Figure 21-S-2116	

Particle Size Distribution Report

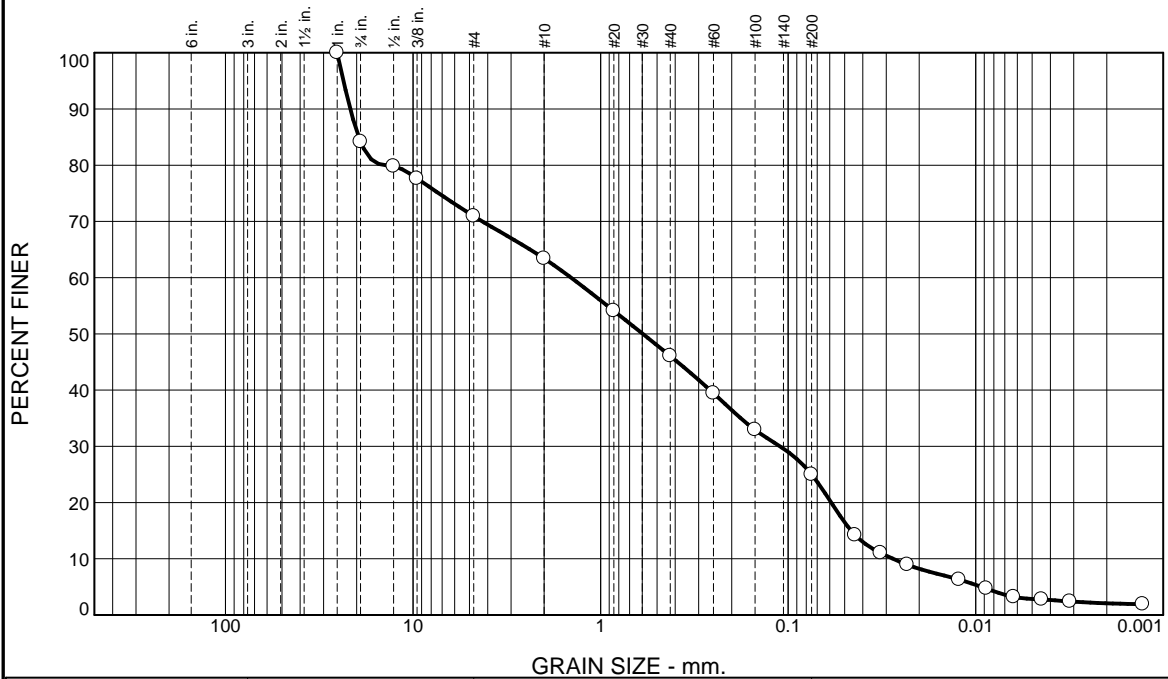

% +3"	% Gravel		% Sand			% Fines	
	Coarse	Fine	Coarse	Medium	Fine	Silt	Clay
0.0	15.8	13.2	7.6	17.3	21.1	22.9	2.1

Test Results (D7928 & ASTM D 1140)			
Opening Size	Percent Finer	Spec.* (Percent)	Pass? (X=Fail)
1"	100.0		
0.75"	84.2		
0.5"	79.8		
0.375"	77.6		
#4	71.0		
#10	63.4		
#20	54.1		
#40	46.1		
#60	39.5		
#100	32.9		
#200	25.0		
0.0440 mm.	14.2		
0.0321 mm.	11.1		
0.0232 mm.	8.9		
0.0123 mm.	6.3		
0.0088 mm.	4.7		
0.0063 mm.	3.2		
0.0044 mm.	2.8		
0.0031 mm.	2.4		
0.0013 mm.	1.9		

* (no specification provided)

Material Description

Gray silty sand with gravel

Atterberg Limits (ASTM D 4318)

PL= NP LL= NV PI= NP

Classification

USCS (D 2487)= SM AASHTO (M 145)= A-1-b

Coefficients

D₉₀= 21.6059 D₈₅= 19.4820 D₆₀= 1.4351
D₅₀= 0.5956 D₃₀= 0.1105 D₁₅= 0.0461
D₁₀= 0.0276 C_u= 51.99 C_c= 0.31

Remarks

Date Received: 06.03.21 Date Tested: 06.09.21

Tested By: JM / MS

Checked By: Steven Accetta

Title: Laboratory Coordinator

Source of Sample: Boring Depth: 7-9'
Sample Number: B-2 / S-5

Date Sampled:

Thielsch Engineering Inc. Cranston, RI	Client: Northeast Geotechnical, Inc. Project: Proposed Residences at Bel Mont Belmont, MA Project No: O432.01
Figure 21-S-2117	

Particle Size Distribution Report

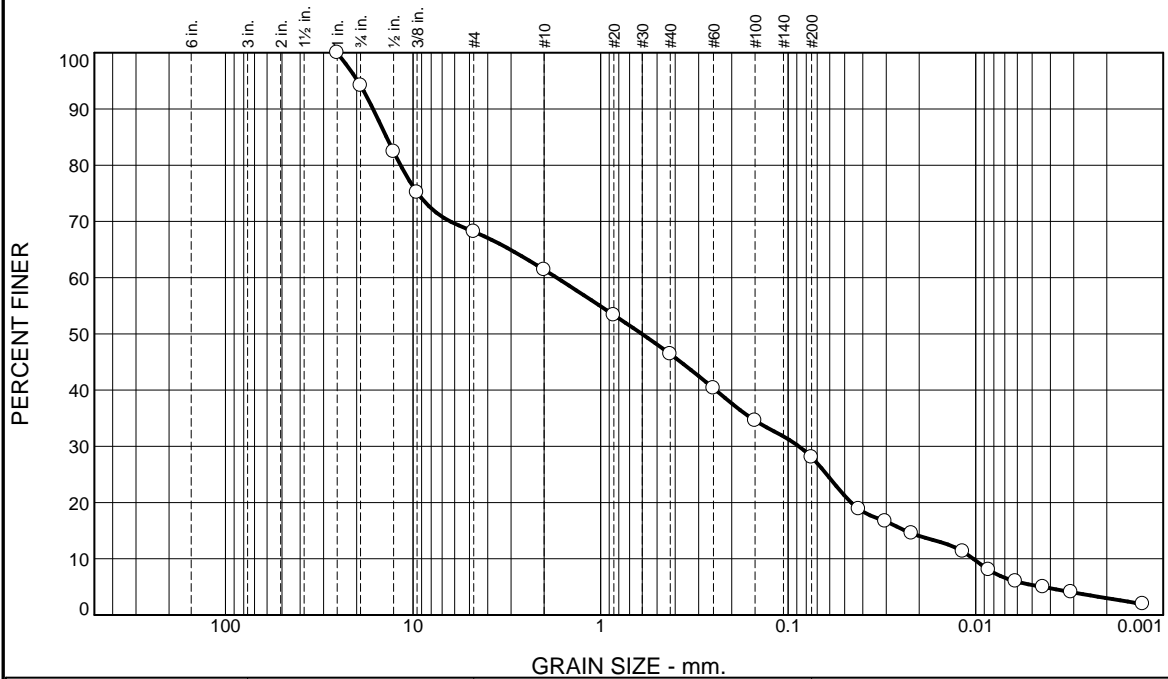

% +3"	% Gravel		% Sand			% Fines	
	Coarse	Fine	Coarse	Medium	Fine	Silt	Clay
0.0	5.8	26.0	6.8	15.0	18.3	25.1	3.0

Test Results (D7928 & ASTM D 1140)			
Opening Size	Percent Finer	Spec.* (Percent)	Pass? (X=Fail)
1"	100.0		
0.75"	94.2		
0.5"	82.4		
0.375"	75.2		
#4	68.2		
#10	61.4		
#20	53.3		
#40	46.4		
#60	40.3		
#100	34.6		
#200	28.1		
0.0420 mm.	18.9		
0.0304 mm.	16.7		
0.0220 mm.	14.5		
0.0117 mm.	11.3		
0.0085 mm.	8.1		
0.0061 mm.	6.0		
0.0044 mm.	5.0		
0.0031 mm.	4.1		
0.0013 mm.	2.0		

* (no specification provided)

Material Description

Gray silty sand with gravel

Atterberg Limits (ASTM D 4318)

PL= NP LL= NV PI= NP

Classification

USCS (D 2487)= SM AASHTO (M 145)= A-2-4(0)

Coefficients

D₉₀= 16.3478 D₈₅= 13.8519 D₆₀= 1.7151
D₅₀= 0.6026 D₃₀= 0.0877 D₁₅= 0.0237
D₁₀= 0.0103 C_u= 166.61 C_c= 0.44

Remarks

Date Received: 06.03.21 Date Tested: 06.09.21

Tested By: JM / MS

Checked By: Steven Accetta

Title: Laboratory Coordinator

Source of Sample: Boring Depth: 5.8-7.8'
Sample Number: B-3 / S-3

Date Sampled:

Thielsch Engineering Inc. Cranston, RI	Client: Northeast Geotechnical, Inc. Project: Proposed Residences at Bel Mont Belmont, MA Project No: O432.01
Figure 21-S-2118	

USDA Soil Classification

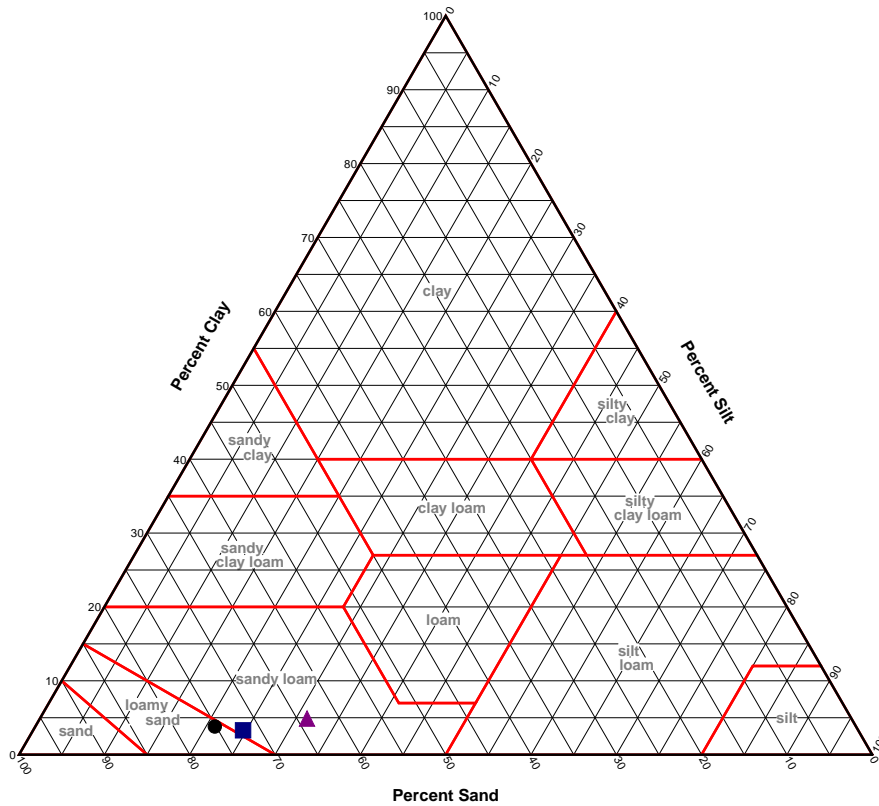

SOIL DATA

	Source	Sample No.	Depth	Percentages From Material Passing a #10 Sieve			Classification
				Sand	Silt	Clay	
●	Boring	B-1 / S-4	6-8'	75.1	21.2	3.7	Loamy sand
■	Boring	B-2 / S-5	7-9'	72.1	24.6	3.3	Sandy loam
▲	Boring	B-3 / S-3	5.8-7.8'	63.8	31.3	4.9	Sandy loam

Thielsch Engineering Inc.
Cranston, RI

Client: Northeast Geotechnical, Inc.
Project: Proposed Residences at Bel Mont
Belmont, MA
Project No.: O432.01

Figure 2116 to 2118

Checked By: sa



195 Frances Avenue
 Cranston RI, 02910
 Phone: (401)-467-6454
 Fax: (401)-467-2398
thielsch.com
Let's Build a Solid Foundation

Client Information:
 Northeast Geotechnical, Inc.
 North Attleborough, MA
 PM: Glenn A. Olson, P.E.
 Assigned By: Christian Rice, P.E.
 Collected By: Christian Rice, P.E.

Project Information:
**Proposed Residences at Bel Mont
 Belmont, MA**
 NEG Project Number: O432.01
 Summary Page: 1 of 1
 Report Date: 06.14.21

LABORATORY TESTING DATA SHEET, Report No.: 7421-F-139

Source	Sample No.	Depth (Ft)	Laboratory No.	Identification Tests								Proctor / CBR / Permeability Tests							Laboratory Log and Soil Description	
				As Received Water Content %	LL %	PL %	Gravel %	Sand %	Fines %	Org. %	G _s	Dry unit wt. pcf	Test Water Content %	γ_d MAX (pcf) W _{opt} (%)	γ_d MAX (pcf) W _{opt} (%) (Corr.)	Target Test Setup as % of Proctor	CBR @ 0.1"	CBR @ 0.2"		Permeability cm/sec
				D2216	D4318		D6913			D2974	D854			D1557						
B-4	S-4	8.3-9.9	21-S-2196				36.2	38.3	25.5											Brown sandy loam
B-5	S-3	5-6.54	21-S-2197				54.0	34.0	12.0											Brown sandy loam
B-6	S-3	5.1-6	21-S-2198				21.7	37.2	41.1											Brown sandy loam

Date Received: 06.07.21

Reviewed By: 

Date Reviewed: 06.14.21

This report only relates to items inspect and/or tested. No warranty, expressed or implied, is made.
 This report shall not be reproduced, except in full, without prior written approval from the Agency, as defined in ASTM E329.

Particle Size Distribution Report

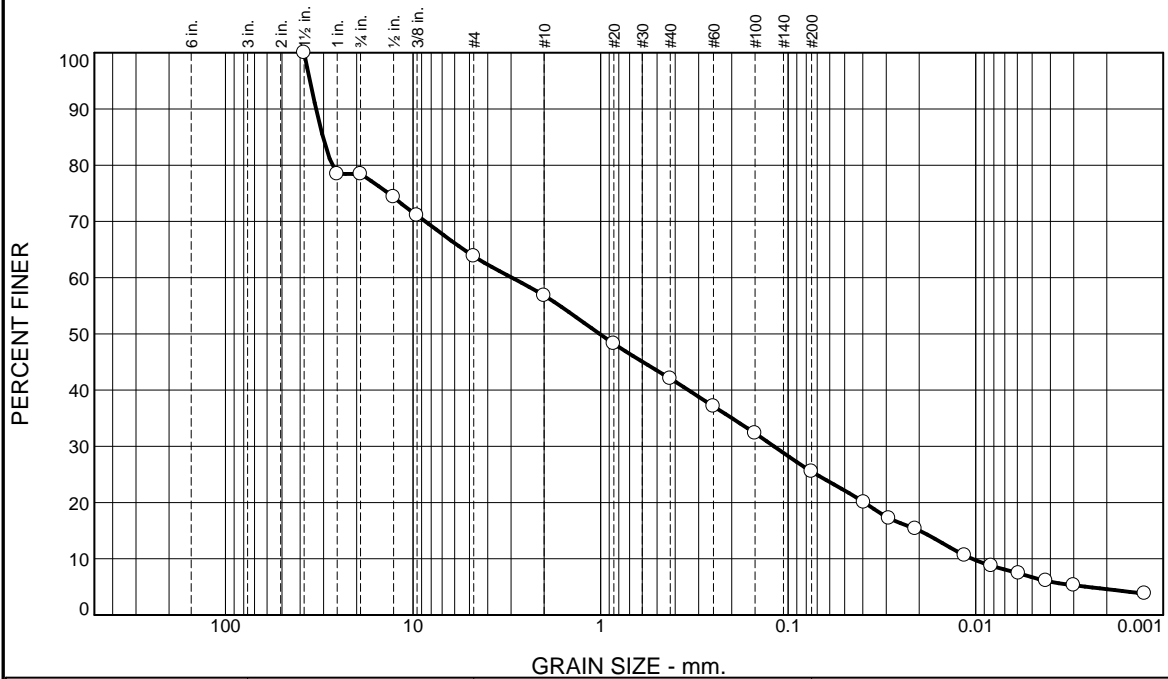

% +3"	% Gravel		% Sand			% Fines	
	Coarse	Fine	Coarse	Medium	Fine	Silt	Clay
0.0	21.5	14.7	7.0	14.7	16.6	20.9	4.6

Test Results (D7928 & ASTM D 1140)			
Opening Size	Percent Finer	Spec.* (Percent)	Pass? (X=Fail)
1-1/2"	100.0		
1"	78.5		
3/4"	78.5		
1/2"	74.3		
3/8"	71.1		
#4	63.8		
#10	56.8		
#20	48.3		
#40	42.1		
#60	37.1		
#100	32.3		
#200	25.5		
0.0395 mm.	20.1		
0.0290 mm.	17.2		
0.0210 mm.	15.3		
0.0114 mm.	10.6		
0.0082 mm.	8.8		
0.0059 mm.	7.4		
0.0042 mm.	6.1		
0.0030 mm.	5.3		
0.0013 mm.	3.8		

* (no specification provided)

Material Description

Brown sandy loam

Atterberg Limits (ASTM D 4318)

PL= NP LL= NV PI= NP

Classification

USCS (D 2487)= SM AASHTO (M 145)= A-2-4(0)

Coefficients

D₉₀= 32.8825 D₈₅= 30.2013 D₆₀= 2.9724
D₅₀= 1.0123 D₃₀= 0.1190 D₁₅= 0.0199
D₁₀= 0.0104 C_u= 284.73 C_c= 0.46

Remarks

Date Received: 06.07.21 Date Tested: 06.11.21

Tested By: JM / MS

Checked By: Steven Accetta

Title: Laboratory Coordinator

Source of Sample: Boring Depth: 8.3-9.9'
Sample Number: B-4 / S-4

Date Sampled:

Thielsch Engineering Inc. Cranston, RI	<p>Client: Northeast Geotechnical, Inc.</p> <p>Project: Proposed Residences at Bel Mont Belmont, MA</p> <p>Project No: O432.01</p>
Figure 21-S-2196	

Particle Size Distribution Report

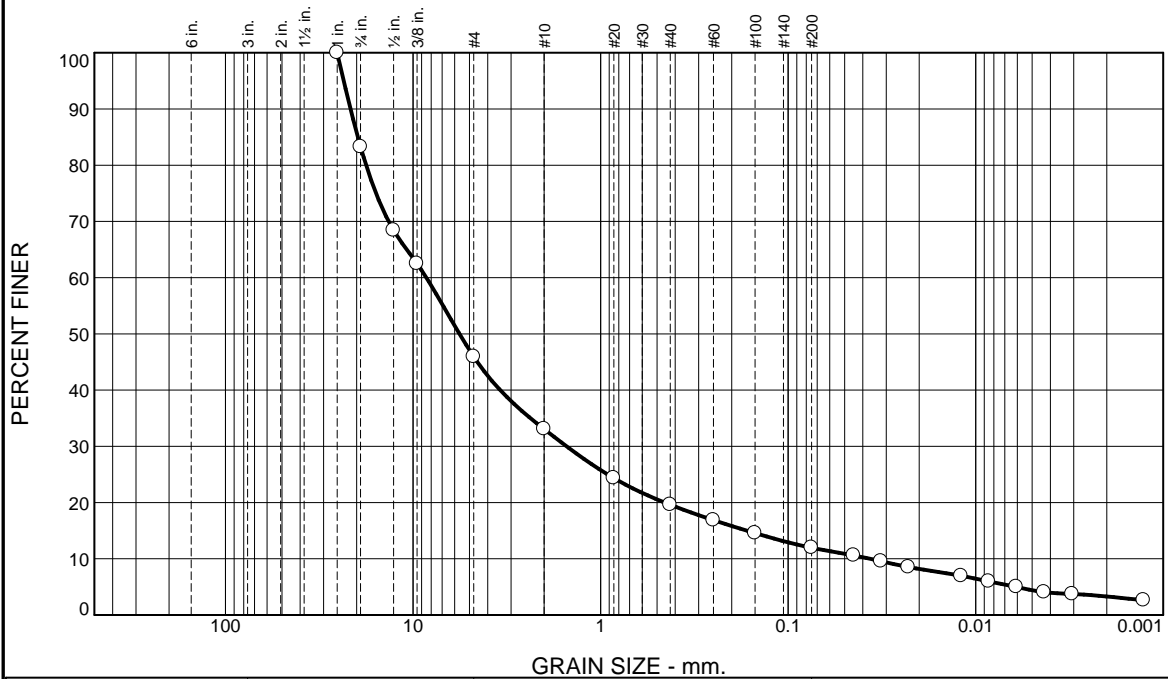

% +3"	% Gravel		% Sand			% Fines	
	Coarse	Fine	Coarse	Medium	Fine	Silt	Clay
0.0	16.7	37.3	12.9	13.5	7.6	8.7	3.3

Test Results (D7928 & ASTM D 1140)			
Opening Size	Percent Finer	Spec.* (Percent)	Pass? (X=Fail)
1"	100.0		
0.75"	83.3		
0.5"	68.4		
0.375"	62.5		
#4	46.0		
#10	33.1		
#20	24.3		
#40	19.6		
#60	16.9		
#100	14.6		
#200	12.0		
0.0447 mm.	10.6		
0.0320 mm.	9.6		
0.0228 mm.	8.5		
0.0120 mm.	7.0		
0.0085 mm.	6.0		
0.0061 mm.	5.0		
0.0043 mm.	4.1		
0.0031 mm.	3.7		
0.0013 mm.	2.6		

* (no specification provided)

Material Description

Brown sandy loam

Atterberg Limits (ASTM D 4318)

PL= NP LL= NV PI= NP

Classification

USCS (D 2487)= GP-GM AASHTO (M 145)= A-1-a

Coefficients

D₉₀= 21.5398 D₈₅= 19.6949 D₆₀= 8.4904
D₅₀= 5.6571 D₃₀= 1.5175 D₁₅= 0.1659
D₁₀= 0.0366 C_u= 231.90 C_c= 7.41

Remarks

Date Received: 06.07.21 Date Tested: 06.11.21

Tested By: JM / MS

Checked By: Steven Accetta

Title: Laboratory Coordinator

Source of Sample: Boring Depth: 5-6.5'
Sample Number: B-5 / S-3

Date Sampled:

Thielsch Engineering Inc. Cranston, RI	Client: Northeast Geotechnical, Inc. Project: Proposed Residences at Bel Mont Belmont, MA Project No: O432.01
Figure 21-S-2197	

Particle Size Distribution Report

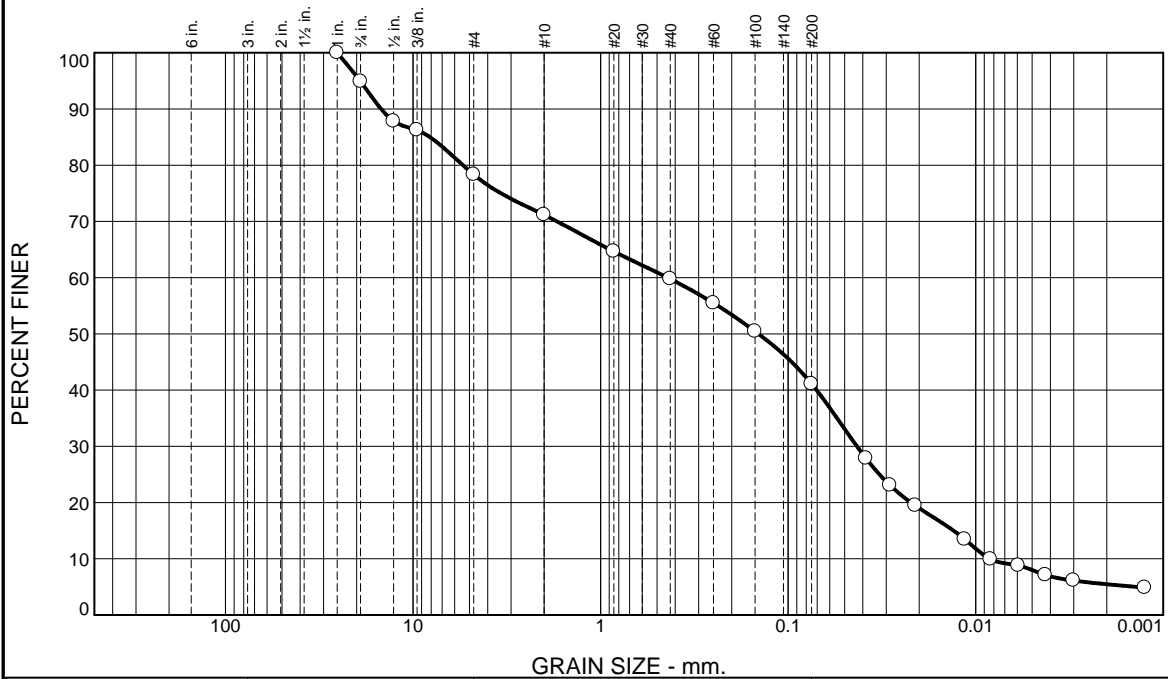

% +3"	% Gravel		% Sand			% Fines	
	Coarse	Fine	Coarse	Medium	Fine	Silt	Clay
0.0	5.1	16.6	7.1	11.4	18.7	35.6	5.5

Test Results (D7928 & ASTM D 1140)			
Opening Size	Percent Finer	Spec.* (Percent)	Pass? (X=Fail)
1"	100.0		
0.75"	94.9		
0.5"	87.8		
0.375"	86.3		
#4	78.3		
#10	71.2		
#20	64.7		
#40	59.8		
#60	55.5		
#100	50.5		
#200	41.1		
0.0384 mm.	27.9		
0.0286 mm.	23.1		
0.0210 mm.	19.5		
0.014 mm.	13.5		
0.0083 mm.	9.9		
0.0059 mm.	8.8		
0.0042 mm.	7.1		
0.0030 mm.	6.1		
0.0013 mm.	4.9		

* (no specification provided)

Material Description

Brown sandy loam

Atterberg Limits (ASTM D 4318)

PL= NP LL= NV PI= NP

Classification

USCS (D 2487)= SM AASHTO (M 145)= A-4(0)

Coefficients

D₉₀= 14.8115 D₈₅= 8.1212 D₆₀= 0.4386
D₅₀= 0.1439 D₃₀= 0.0430 D₁₅= 0.0131
D₁₀= 0.0084 C_u= 52.09 C_c= 0.50

Remarks

Sample visually classified as non-plastic.

Date Received: 06.07.21 Date Tested: 06.11.21

Tested By: JM / MS

Checked By: Steven Accetta

Title: Laboratory Coordinator

Source of Sample: Boring Depth: 5.1-6'
Sample Number: B-6 / S-3

Date Sampled:

Thielsch Engineering Inc. Cranston, RI	Client: Northeast Geotechnical, Inc. Project: Proposed Residences at Bel Mont Belmont, MA Project No: O432.01
Figure 21-S-2198	

USDA Soil Classification

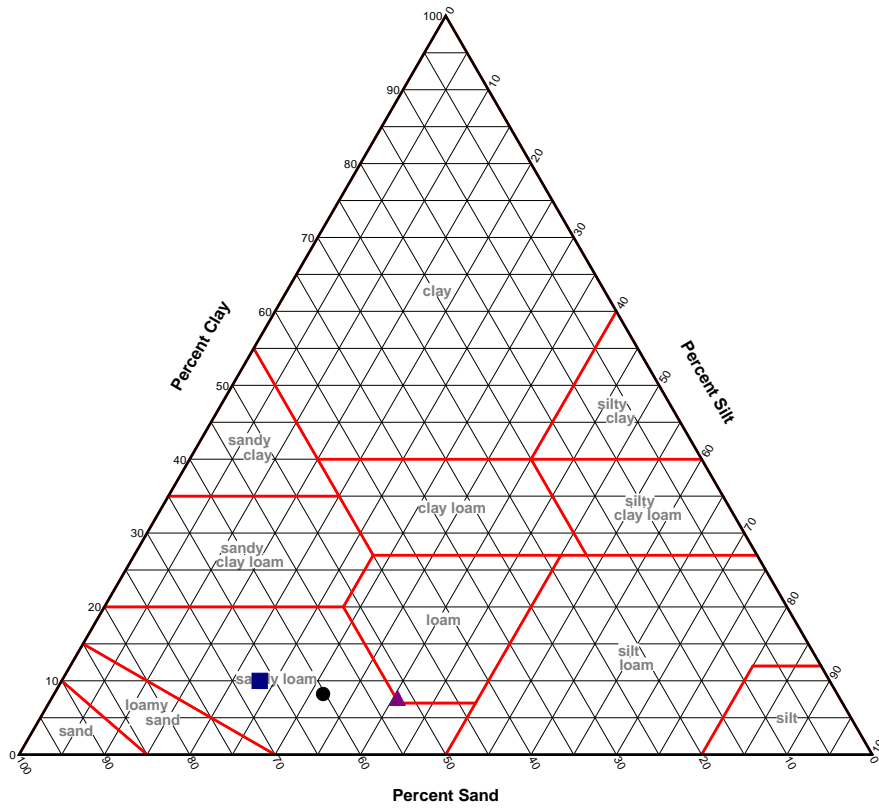

SOIL DATA

	Source	Sample No.	Depth	Percentages From Material Passing a #10 Sieve			Classification
				Sand	Silt	Clay	
●	Boring	B-4 / S-4	8.3-9.9'	60.2	31.7	8.1	Sandy loam
■	Boring	B-5 / S-3	5-6.5'	66.8	23.3	10.0	Sandy loam
▲	Boring	B-6 / S-3	5.1-6'	51.8	40.4	7.7	Sandy loam

Thielsch Engineering Inc.
Cranston, RI

Client: Northeast Geotechnical, Inc.
Project: Proposed Residences at Bel Mont
Belmont, MA
Project No.: O432.01

Figure 2196 to 2198

Checked By: sa

Appendix D: Standard 4 Computations and Supporting Information

- › Long-Term Pollution Prevention Plan
- › Water Quality Volume Calculations
- › TSS Removal Worksheets

Long-term Pollution Prevention Plan



Long-Term Pollution Prevention Plan

This Long-Term Pollution Prevention Plan has been developed to establish site management practices that improve the quality of stormwater discharges from the Project.

Pollutant Control Approach

Maintenance of Pavement Systems

Standard Asphalt Pavement

Regular maintenance of pavement surfaces will prevent pollutants such as oil and grease, trash, and sediments from entering the stormwater management system. The following practices should be performed:

- Sweep or vacuum asphalt pavement areas [semi-annually, annually, monthly, etc with a commercial cleaning unit and dispose of removed material.
- Check loading docks and dumpster areas frequently for spillage and/or pavement staining and clean as necessary
- Routinely pick up and remove litter from the parking areas, islands, and perimeter landscaping.

Maintenance of Vegetated Areas

Proper maintenance of vegetated areas can prevent the pollution of stormwater runoff by controlling the source of pollutants such as suspended sediments, excess nutrients, and chemicals from landscape care products. Practices that should be followed under the regular maintenance of the vegetated landscape include:

- Inspect planted areas on a semi-annual basis and remove any litter.
- Maintain planted areas adjacent to pavement to prevent soil washout.
- Immediately clean any soil deposited on pavement.
- Re-seed bare areas; install appropriate erosion control measures when native soil is exposed or erosion channels are forming.
- Plant alternative mixture of grass species in the event of unsuccessful establishment.



- The grass vegetation should be cut to a height between three and four inches.
- Pesticide/Herbicide Usage – No pesticides are to be used unless a single spot treatment is required for a specific control application.
- Fertilizer usage should be avoided. If deemed necessary, slow release fertilizer should be used. Fertilizer may be used to begin the establishment of vegetation in bare or damaged areas, but should not be applied on a regular basis unless necessary.
- Pet waste provision if applicable.

Management of Snow and Ice

Storage and Disposal

Snow will be plowed off streets. Residents will be responsible for snow removal on driveways. Key practices for the safe storage and disposal of snow include:

- Under no circumstances shall snow be disposed or stored in wetland resource areas.
- Under no circumstances shall snow be disposed or stored in stormwater basins, ponds, rain gardens, swales, channels, or trenches.

Salt and Deicing Chemicals

The amount of salt and deicing chemicals to be used on the site shall be reduced to the minimum amount needed to provide safe pedestrian and vehicle travel. The following practices should be followed to control the amount of salt and deicing materials that come into contact with stormwater runoff:

- Devices used for spreading salt and deicing chemicals should be capable of varying the rate of application based on the site specific conditions.
- Specific environmentally sensitive areas should be designated as no and/or reduced salt areas.
- Alternate materials [list alternate materials] should be used in place of standard salt and deicing chemicals in specific environmentally sensitive areas [engineer to identify].
- Sand and salt should be stockpiled under covered storage facilities that prevent precipitation and adjacent runoff from coming in contact with the deicing materials



Spill Prevention and Response Plan

Spill prevention equipment and training will be provided by the property management company.

Initial Notification

In the event of a spill the facility and/or construction manager or supervisor will be notified immediately.

FACILITY MANAGER

Name: TBD Home Phone: _____
Phone: _____ E-mail: _____

CONSTRUCTION MANAGER

Name: TBD Home Phone: _____
Phone: _____ E-mail: _____

The supervisor will first contact the Fire Department and then notify the Police Department, the Public Health Commission and the Conservation Commission. The Fire Department is ultimately responsible for matters of public health and safety and should be notified immediately.

Further Notification

Based on the assessment from the Fire Chief, additional notification to a cleanup contractor may be made. The Department of Environmental Protection (DEP) and the EPA may be notified depending upon the nature and severity of the spill. The Fire Chief will be responsible for determining the level of cleanup and notification required. The attached list of emergency phone numbers shall be posted in the main construction/facility office and readily accessible to all employees. A hazardous waste spill report shall be completed as necessary using the attached form.



Emergency Notification Phone Numbers

1. FACILITY MANAGER

Name: TBD Home Phone: _____

Phone: _____ E-mail: _____

ALTERNATE

Name: _____ Home Phone: _____

Phone: _____ E-mail: _____

2. FIRE DEPARTMENT

Emergency: 911

Business: 617-993-2200

POLICE DEPARTMENT

Emergency: 911

Business: 617-484-1212

3. CLEANUP CONTRACTOR: TBD

Address: _____

Phone: _____

4. MASSACHUSETTS DEPARTMENT OF ENVIRONMENTAL PROTECTION

Emergency: _____

Northeast Region – Woburn Office: 978-694-3200

5. NATIONAL RESPONSE CENTER

Phone: (800) 424-8802

ALTERNATE: U.S. ENVIRONMENTAL PROTECTION AGENCY

Emergency: _____

Business: _____

6. CONSERVATION COMMISSION

Contact: Mary Trudeau

Phone: 617-993-2667

BOARD OF HEALTH

Contact: Wesley Chin

Phone: 617-993-2720



Hazardous Waste / Oil Spill Report

Date _____ Time _____ AM / PM

Exact location (Transformer #) _____

Type of equipment _____ Make _____ Size _____

S / N _____ Weather Conditions _____

On or near Water Yes If Yes, name of body of Water _____

No

Type of chemical/oil spilled _____

Amount of chemical/oil spilled _____

Cause of Spill _____

Measures taken to contain or clean up spill _____

Amount of chemical/oil recovered _____ Method _____

Material collected as a result of cleanup:

_____ Drums containing _____

_____ Drums containing _____

_____ Drums containing _____

Location and method of debris disposal

Name and address of any person, firm, or corporation suffering damages:

Procedures, method, and precautions instituted to prevent a similar occurrence from recurring:

Spill reported to General Office by _____ Time _____ AM / PM

Spill reported to DEP / National Response Center by _____

DEP Date _____ Time _____ AM / PM Inspector _____

NRC Date _____ Time _____ AM / PM Inspector _____

Additional comments: _____



Assessment - Initial Containment

The supervisor or manager will assess the incident and initiate containment control measures with the appropriate spill containment equipment included in the spill kit kept on-site. A list of recommended spill equipment to be kept on site is included on the following page.

Fire / Police Department	<u>911</u>
Municipality Health Department	<u>617-993-2720</u>
Municipality Conservation Commission:	<u>617-993-2667</u>



Emergency Response Equipment

The following equipment and materials shall be maintained at all times and stored in a secure area for long-term emergency response need.

Supplies		Recommended Suppliers
SORBENT PILLOWS/"PIGS"	2	http://www.newpig.com
SORBENT BOOM/SOCK	25 FEET	Item # KIT276 — mobile container with two pigs,
SORBENT PADS	50	26 feet of sock, 50 pads, and five pounds of
LITE-DRI® ABSORBENT	5	absorbent (or equivalent)
POUNDS		http://www.forestry-suppliers.com
SHOVEL	1	Item # 43210 — Manhole cover pick (or
PRY BAR	1	equivalent)
GOGGLES	1 PAIR	Item # 33934 — Shovel (or equivalent)
GLOVES – HEAVY	1 PAIR	Item # 90926 — Gloves (or equivalent)
		Item # 23334 — Goggles (or equivalent)



Stormwater Operation and Maintenance Plan

Project Information

Site

Residences at Bel Mont
Olmsted Drive
Belmont, Massachusetts

Owner

McLean Hospital Corp
115 Mill Street
Belmont, MA 02478

Site Supervisor

TBD

Name: _____

Telephone: _____

Cell phone: _____

Email: _____



Description of Stormwater Maintenance Measures

The following Operation and Maintenance (O&M) program is proposed to ensure the continued effectiveness of the stormwater management system. Attached to this plan are a Stormwater Best Management Practices Checklist and Maintenance Figure for use during the long term operation and maintenance of the stormwater management system.

Catch Basins

- All catch basins shall be inspected and cleaned a minimum of at least once per year.
- Sediment (if more than six inches deep) and/or floatable pollutants shall be pumped from the basin and disposed of at an approved offsite facility in accordance with all applicable regulations.
- Any structural damage or other indication of malfunction will be reported to the site manager and repaired as necessary
- During colder periods, the catch basin grates must be kept free of snow and ice.
- During warmer periods, the catch basin grates must be kept free of leaves, litter, sand, and debris.

Subsurface Detention Systems/Sand Filters

- The subsurface systems will be inspected at least once each year by removing the manhole/access port covers and determining the thickness of sediment that has accumulated in the sediment removal row (stilling basin).
- If sediment is more than six inches deep, it must be suspended via flushing with clean water and removed using a vactor truck.
- Manufacturer's specifications and instructions for cleaning the sediment removal row is provided as an attachment to this section.
- Emergency overflow pipes will be examined at least once each year and verified that no blockage has occurred.
- System will be observed after rainfalls to see if it is properly draining.

Structural Water Quality Devices

- Inspect devices monthly for the first three months after construction.
- After initial three month period, all water quality units are to be inspected at least four times per year and cleaned a minimum of at least once per year or when sediment reaches 8" in depth.
- Follow manufacturer instructions for inspection and cleaning and contact manufacturer if system is malfunctioning.



Stormwater Outfalls

- Inspect outfall locations monthly for the first three months after construction to ensure proper functioning and correct any areas that have settled or experienced washouts.
- Inspect outfalls annually after initial three month period.
- Annual inspections should be supplemented after large storms, when washouts may occur.
- Maintain vegetation around outfalls to prevent blockages at the outfall.
- Maintain rip rap pad below each outfall and replace any washouts.
- Remove and dispose of any trash or debris at the outfall.

Roof Drain Leaders

- Perform routine roof inspections quarterly.
- Keep roofs clean and free of debris.
- Keep roof drainage systems clear.
- Keep roof access limited to authorized personnel.
- Clean inlets draining to the subsurface bed twice per year as necessary.

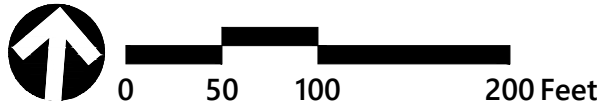

StormFilter Inspection and Maintenance Procedures



Maintenance Guidelines

The primary purpose of the Stormwater Management StormFilter® is to filter and prevent pollutants from entering our waterways. Like any effective filtration system, periodically these pollutants must be removed to restore the StormFilter to its full efficiency and effectiveness.

Maintenance requirements and frequency are dependent on the pollutant load characteristics of each site. Maintenance activities may be required in the event of a chemical spill or due to excessive sediment loading from site erosion or extreme storms. It is a good practice to inspect the system after major storm events.

Maintenance Procedures

Although there are many effective maintenance options, we believe the following procedure to be efficient, using common equipment and existing maintenance protocols. The following two-step procedure is recommended::

1. Inspection

- Inspection of the vault interior to determine the need for maintenance.

2. Maintenance

- Cartridge replacement
- Sediment removal

Inspection and Maintenance Timing

At least one scheduled inspection should take place per year with maintenance following as warranted.

First, an inspection should be done before the winter season. During the inspection the need for maintenance should be determined and, if disposal during maintenance will be required, samples of the accumulated sediments and media should be obtained.

Second, if warranted, a maintenance (replacement of the filter cartridges and removal of accumulated sediments) should be performed during periods of dry weather.

In addition to these two activities, it is important to check the condition of the StormFilter unit after major storms for potential damage caused by high flows and for high sediment accumulation that may be caused by localized erosion in the drainage area. It may be necessary to adjust the inspection/maintenance schedule depending on the actual operating conditions encountered by the system. In general, inspection activities can be conducted at any time, and maintenance should occur, if warranted, during dryer months in late summer to early fall.

Maintenance Frequency

The primary factor for determining frequency of maintenance for the StormFilter is sediment loading.

A properly functioning system will remove solids from water by trapping particulates in the porous structure of the filter media inside the cartridges. The flow through the system will naturally decrease as more and more particulates are trapped. Eventually the flow through the cartridges will be low enough to require replacement. It may be possible to extend the usable span of the cartridges by removing sediment from upstream trapping devices on a routine as-needed basis, in order to prevent material from being re-suspended and discharged to the StormFilter treatment system.

The average maintenance lifecycle is approximately 1-5 years. Site conditions greatly influence maintenance requirements. StormFilter units located in areas with erosion or active construction may need to be inspected and maintained more often than those with fully stabilized surface conditions.

Regulatory requirements or a chemical spill can shift maintenance timing as well. The maintenance frequency may be adjusted as additional monitoring information becomes available during the inspection program. Areas that develop known problems should be inspected more frequently than areas that demonstrate no problems, particularly after major storms. Ultimately, inspection and maintenance activities should be scheduled based on the historic records and characteristics of an individual StormFilter system or site. It is recommended that the site owner develop a database to properly manage StormFilter inspection and maintenance programs..





Inspection Procedures

The primary goal of an inspection is to assess the condition of the cartridges relative to the level of visual sediment loading as it relates to decreased treatment capacity. It may be desirable to conduct this inspection during a storm to observe the relative flow through the filter cartridges. If the submerged cartridges are severely plugged, then typically large amounts of sediments will be present and very little flow will be discharged from the drainage pipes. If this is the case, then maintenance is warranted and the cartridges need to be replaced.

Warning: In the case of a spill, the worker should abort inspection activities until the proper guidance is obtained. Notify the local hazard control agency and Contech Engineered Solutions immediately.

To conduct an inspection:

Important: Inspection should be performed by a person who is familiar with the operation and configuration of the StormFilter treatment unit and the unit's role, relative to detention or retention facilities onsite.

1. If applicable, set up safety equipment to protect and notify surrounding vehicle and pedestrian traffic.
2. Visually inspect the external condition of the unit and take notes concerning defects/problems.
3. Open the access portals to the vault and allow the system vent.
4. Without entering the vault, visually inspect the inside of the unit, and note accumulations of liquids and solids.
5. Be sure to record the level of sediment build-up on the floor of the vault, in the forebay, and on top of the cartridges. If flow is occurring, note the flow of water per drainage pipe. Record all observations. Digital pictures are valuable for historical documentation.
6. Close and fasten the access portals.
7. Remove safety equipment.
8. If appropriate, make notes about the local drainage area relative to ongoing construction, erosion problems, or high loading of other materials to the system.
9. Discuss conditions that suggest maintenance and make decision as to whether or not maintenance is needed.

Maintenance Decision Tree

The need for maintenance is typically based on results of the inspection. The following Maintenance Decision Tree should be used as a general guide. (Other factors, such as Regulatory Requirements, may need to be considered).

Please note Stormwater Management StormFilter devices installed downstream of, or integrated within, a stormwater storage facility typically have different operational parameters (i.e. draindown time). In these cases, the inspector must understand the relationship between the retention/detention facility and the treatment system by evaluating site specific civil engineering plans, or contacting the engineer of record, and make adjustments to the below guidance as necessary. Sediment deposition depths and patterns within the StormFilter are likely to be quite different compared to systems without upstream storage and therefore shouldn't be used exclusively to evaluate a need for maintenance.

1. Sediment loading on the vault floor.
 - a. If >4 " of accumulated sediment, maintenance is required.
2. Sediment loading on top of the cartridge.
 - a. If $>1/4$ " of accumulation, maintenance is required.
3. Submerged cartridges.
 - a. If >4 " of static water above cartridge bottom for more than 24 hours after end of rain event, maintenance is required. (Catch basins have standing water in the cartridge bay.)
4. Plugged media.
 - a. While not required in all cases, inspection of the media within the cartridge may provide valuable additional information.
 - b. If pore space between media granules is absent, maintenance is required.
5. Bypass condition.
 - a. If inspection is conducted during an average rain fall event and StormFilter remains in bypass condition (water over the internal outlet baffle wall or submerged cartridges), maintenance is required.
6. Hazardous material release.
 - a. If hazardous material release (automotive fluids or other) is reported, maintenance is required.
7. Pronounced scum line.
 - a. If pronounced scum line (say $\geq 1/4$ " thick) is present above top cap, maintenance is required.

Maintenance

Depending on the configuration of the particular system, maintenance personnel will be required to enter the vault to perform the maintenance.

Important: If vault entry is required, OSHA rules for confined space entry must be followed.

Filter cartridge replacement should occur during dry weather. It may be necessary to plug the filter inlet pipe if base flows is occurring.

Replacement cartridges can be delivered to the site or customers facility. Information concerning how to obtain the replacement cartridges is available from Contech Engineered Solutions.

Warning: In the case of a spill, the maintenance personnel should abort maintenance activities until the proper guidance is obtained. Notify the local hazard control agency and Contech Engineered Solutions immediately.

To conduct cartridge replacement and sediment removal maintenance:

1. If applicable, set up safety equipment to protect maintenance personnel and pedestrians from site hazards.
2. Visually inspect the external condition of the unit and take notes concerning defects/problems.
3. Open the doors (access portals) to the vault and allow the system to vent.
4. Without entering the vault, give the inside of the unit, including components, a general condition inspection.
5. Make notes about the external and internal condition of the vault. Give particular attention to recording the level of sediment build-up on the floor of the vault, in the forebay, and on top of the internal components.
6. Using appropriate equipment offload the replacement cartridges (up to 150 lbs. each) and set aside.
7. Remove used cartridges from the vault using one of the following methods:

Method 1:

- A. This activity will require that maintenance personnel enter the vault to remove the cartridges from the under drain manifold and place them under the vault opening for lifting (removal). Disconnect each filter cartridge from the underdrain connector by rotating counterclockwise 1/4 of a turn. Roll the loose cartridge, on edge, to a convenient spot beneath the vault access.

Using appropriate hoisting equipment, attach a cable from the boom, crane, or tripod to the loose cartridge. Contact Contech Engineered Solutions for suggested attachment devices.

- B. Remove the used cartridges (up to 250 lbs. each) from the vault.



Important: Care must be used to avoid damaging the cartridges during removal and installation. The cost of repairing components damaged during maintenance will be the responsibility of the owner.

- C. Set the used cartridge aside or load onto the hauling truck.
- D. Continue steps a through c until all cartridges have been removed.

Method 2:

- A. This activity will require that maintenance personnel enter the vault to remove the cartridges from the under drain manifold and place them under the vault opening for lifting (removal). Disconnect each filter cartridge from the underdrain connector by rotating counterclockwise 1/4 of a turn. Roll the loose cartridge, on edge, to a convenient spot beneath the vault access.
- B. Unscrew the cartridge cap.
- C. Remove the cartridge hood and float.
- D. At location under structure access, tip the cartridge on its side.
- E. Empty the cartridge onto the vault floor. Reassemble the empty cartridge.
- F. Set the empty, used cartridge aside or load onto the hauling truck.
- G. Continue steps a through e until all cartridges have been removed.

8. Remove accumulated sediment from the floor of the vault and from the forebay. This can most effectively be accomplished by use of a vacuum truck.
9. Once the sediments are removed, assess the condition of the vault and the condition of the connectors.
10. Using the vacuum truck boom, crane, or tripod, lower and install the new cartridges. Once again, take care not to damage connections.
11. Close and fasten the door.
12. Remove safety equipment.
13. Finally, dispose of the accumulated materials in accordance with applicable regulations. Make arrangements to return the used **empty** cartridges to Contech Engineered Solutions.

Related Maintenance Activities - Performed on an as-needed basis

StormFilter units are often just one of many structures in a more comprehensive stormwater drainage and treatment system.

In order for maintenance of the StormFilter to be successful, it is imperative that all other components be properly maintained. The maintenance/repair of upstream facilities should be carried out prior to StormFilter maintenance activities.

In addition to considering upstream facilities, it is also important to correct any problems identified in the drainage area. Drainage area concerns may include: erosion problems, heavy oil loading, and discharges of inappropriate materials.

Material Disposal

The accumulated sediment found in stormwater treatment and conveyance systems must be handled and disposed of in accordance with regulatory protocols. It is possible for sediments to contain measurable concentrations of heavy metals and organic chemicals (such as pesticides and petroleum products). Areas with the greatest potential for high pollutant loading include industrial areas and heavily traveled roads.

Sediments and water must be disposed of in accordance with all applicable waste disposal regulations. When scheduling maintenance, consideration must be made for the disposal of solid and liquid wastes. This typically requires coordination with a local landfill for solid waste disposal. For liquid waste disposal a number of options are available including a municipal vacuum truck decant facility, local waste water treatment plant or on-site treatment and discharge.



Inspection Report

Date: _____ Personnel: _____

Location: _____ System Size: _____ Months in Service: _____

System Type: Vault Cast-In-Place Linear Catch Basin Manhole Other: _____

Sediment Thickness in Forebay: _____ Date: _____

Sediment Depth on Vault Floor: _____

Sediment Depth on Cartridge Top(s): _____

Structural Damage: _____

Estimated Flow from Drainage Pipes (if available): _____

Cartridges Submerged: Yes No Depth of Standing Water: _____

StormFilter Maintenance Activities (check off if done and give description)

Trash and Debris Removal: _____

Minor Structural Repairs: _____

Drainage Area Report _____

Excessive Oil Loading: Yes No Source: _____

Sediment Accumulation on Pavement: Yes No Source: _____

Erosion of Landscaped Areas: Yes No Source: _____

Items Needing Further Work: _____

Owners should contact the local public works department and inquire about how the department disposes of their street waste residuals.

Other Comments:

Review the condition reports from the previous inspection visits.

StormFilter Maintenance Report

Date: _____ Personnel: _____

Location: _____ System Size: _____

System Type: Vault Cast-In-Place Linear Catch Basin Manhole Other: _____

List Safety Procedures and Equipment Used: _____

System Observations

Months in Service: _____

Oil in Forebay (if present): Yes No

Sediment Depth in Forebay (if present): _____

Sediment Depth on Vault Floor: _____

Sediment Depth on Cartridge Top(s): _____

Structural Damage: _____

Drainage Area Report

Excessive Oil Loading: Yes No Source: _____

Sediment Accumulation on Pavement: Yes No Source: _____

Erosion of Landscaped Areas: Yes No Source: _____

StormFilter Cartridge Replacement Maintenance Activities

Remove Trash and Debris: Yes No Details: _____

Replace Cartridges: Yes No Details: _____

Sediment Removed: Yes No Details: _____

Quantity of Sediment Removed (estimate?): _____

Minor Structural Repairs: Yes No Details: _____

Residuals (debris, sediment) Disposal Methods: _____

Notes:



© 2020 CONTECH ENGINEERED SOLUTIONS LLC, A QUIKRETE COMPANY

800-338-1122

www.ContechES.com

All Rights Reserved. Printed in the USA.

Contech Engineered Solutions LLC provides site solutions for the civil engineering industry. Contech's portfolio includes bridges, drainage, sanitary sewer, stormwater and earth stabilization products. For information on other Contech division offerings, visit www.ContechES.com or call 800.338.1122.

Support

- Drawings and specifications are available at www.conteches.com.
- Site-specific design support is available from our engineers.

NOTHING IN THIS CATALOG SHOULD BE CONSTRUED AS A WARRANTY. APPLICATIONS SUGGESTED HEREIN ARE DESCRIBED ONLY TO HELP READERS MAKE THEIR OWN EVALUATIONS AND DECISIONS, AND ARE NEITHER GUARANTEES NOR WARRANTIES OF SUITABILITY FOR ANY APPLICATION. CONTECH MAKES NO WARRANTY WHATSOEVER, EXPRESS OR IMPLIED, RELATED TO THE APPLICATIONS, MATERIALS, COATINGS, OR PRODUCTS DISCUSSED HEREIN. ALL IMPLIED WARRANTIES OF MERCHANTABILITY AND ALL IMPLIED WARRANTIES OF FITNESS FOR ANY PARTICULAR PURPOSE ARE DISCLAIMED BY CONTECH. SEE CONTECH'S CONDITIONS OF SALE (AVAILABLE AT WWW.CONTECHES.COM/COS) FOR MORE INFORMATION.

CDS Guide

Operation, Design, Performance and Maintenance



CDS®

Using patented continuous deflective separation technology, the CDS system screens, separates and traps debris, sediment, and oil and grease from stormwater runoff. The indirect screening capability of the system allows for 100% removal of floatables and neutrally buoyant material without blinding. Flow and screening controls physically separate captured solids, and minimize the re-suspension and release of previously trapped pollutants. Inline units can treat up to 6 cfs, and internally bypass flows in excess of 50 cfs (1416 L/s). Available precast or cast-in-place, offline units can treat flows from 1 to 300 cfs (28.3 to 8495 L/s). The pollutant removal capacity of the CDS system has been proven in lab and field testing.

Operation Overview

Stormwater enters the diversion chamber where the diversion weir guides the flow into the unit's separation chamber and pollutants are removed from the flow. All flows up to the system's treatment design capacity enter the separation chamber and are treated.

Swirl concentration and screen deflection force floatables and solids to the center of the separation chamber where 100% of floatables and neutrally buoyant debris larger than the screen apertures are trapped.

Stormwater then moves through the separation screen, under the oil baffle and exits the system. The separation screen remains clog free due to continuous deflection.

During the flow events exceeding the treatment design capacity, the diversion weir bypasses excessive flows around the separation chamber, so captured pollutants are retained in the separation cylinder.

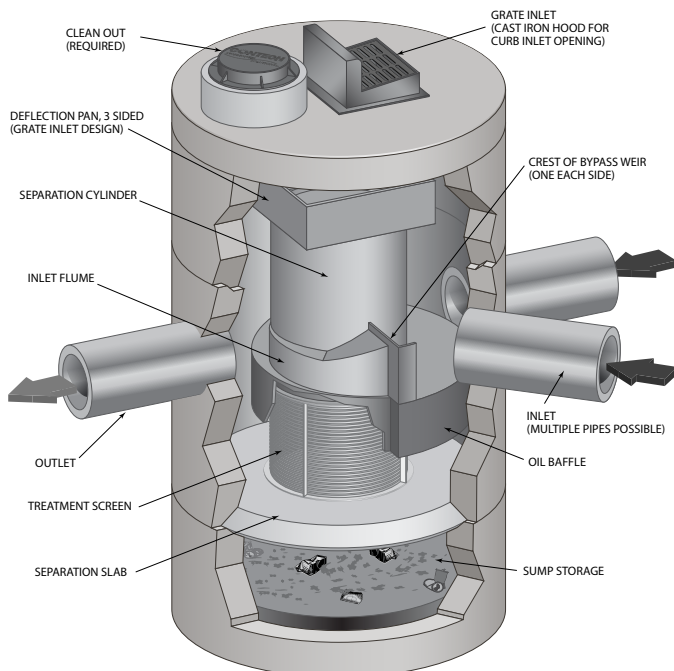

Design Basics

There are three primary methods of sizing a CDS system. The Water Quality Flow Rate Method determines which model size provides the desired removal efficiency at a given flow rate for a defined particle size. The Rational Rainfall Method™ or the Probabilistic Method is used when a specific removal efficiency of the net annual sediment load is required.

Typically in the United States, CDS systems are designed to achieve an 80% annual solids load reduction based on lab generated performance curves for a gradation with an average particle size (d50) of 125 microns (μm). For some regulatory environments, CDS systems can also be designed to achieve an 80% annual solids load reduction based on an average particle size (d50) of 75 microns (μm) or 50 microns (μm).

Water Quality Flow Rate Method

In some cases, regulations require that a specific treatment rate, often referred to as the water quality design flow (WQQ), be treated. This WQQ represents the peak flow rate from either an event with a specific recurrence interval, e.g. the six-month storm, or a water quality depth, e.g. 1/2-inch (13 mm) of rainfall.

The CDS is designed to treat all flows up to the WQQ. At influent rates higher than the WQQ, the diversion weir will direct most flow exceeding the WQQ around the separation chamber. This allows removal efficiency to remain relatively constant in the separation chamber and eliminates the risk of washout during bypass flows regardless of influent flow rates.

Treatment flow rates are defined as the rate at which the CDS will remove a specific gradation of sediment at a specific removal efficiency. Therefore the treatment flow rate is variable, based on the gradation and removal efficiency specified by the design engineer.

Rational Rainfall Method™

Differences in local climate, topography and scale make every site hydraulically unique. It is important to take these factors into consideration when estimating the long-term performance of any stormwater treatment system. The Rational Rainfall Method combines site-specific information with laboratory generated performance data, and local historical precipitation records to estimate removal efficiencies as accurately as possible.

Short duration rain gauge records from across the United States and Canada were analyzed to determine the percent of the total annual rainfall that fell at a range of intensities. US stations' depths were totaled every 15 minutes, or hourly, and recorded in 0.01-inch increments. Depths were recorded hourly with 1-mm resolution at Canadian stations. One trend was consistent at all sites; the vast majority of precipitation fell at low intensities and high intensity storms contributed relatively little to the total annual depth.

These intensities, along with the total drainage area and runoff coefficient for each specific site, are translated into flow rates using the Rational Rainfall Method. Since most sites are relatively small and highly impervious, the Rational Rainfall Method is appropriate. Based on the runoff flow rates calculated for each intensity, operating rates within a proposed CDS system are

determined. Performance efficiency curve determined from full scale laboratory tests on defined sediment PSDs is applied to calculate solids removal efficiency. The relative removal efficiency at each operating rate is added to produce a net annual pollutant removal efficiency estimate.

Probabilistic Rational Method

The Probabilistic Rational Method is a sizing program Contech developed to estimate a net annual sediment load reduction for a particular CDS model based on site size, site runoff coefficient, regional rainfall intensity distribution, and anticipated pollutant characteristics.

The Probabilistic Method is an extension of the Rational Method used to estimate peak discharge rates generated by storm events of varying statistical return frequencies (e.g. 2-year storm event). Under the Rational Method, an adjustment factor is used to adjust the runoff coefficient estimated for the 10-year event, correlating a known hydrologic parameter with the target storm event. The rainfall intensities vary depending on the return frequency of the storm event under consideration. In general, these two frequency dependent parameters (rainfall intensity and runoff coefficient) increase as the return frequency increases while the drainage area remains constant.

These intensities, along with the total drainage area and runoff coefficient for each specific site, are translated into flow rates using the Rational Method. Since most sites are relatively small and highly impervious, the Rational Method is appropriate. Based on the runoff flow rates calculated for each intensity, operating rates within a proposed CDS are determined. Performance efficiency curve on defined sediment PSDs is applied to calculate solids removal efficiency. The relative removal efficiency at each operating rate is added to produce a net annual pollutant removal efficiency estimate.

Treatment Flow Rate

The inlet throat area is sized to ensure that the WQQ passes through the separation chamber at a water surface elevation equal to the crest of the diversion weir. The diversion weir bypasses excessive flows around the separation chamber, thus preventing re-suspension or re-entrainment of previously captured particles.

Hydraulic Capacity

The hydraulic capacity of a CDS system is determined by the length and height of the diversion weir and by the maximum allowable head in the system. Typical configurations allow hydraulic capacities of up to ten times the treatment flow rate. The crest of the diversion weir may be lowered and the inlet throat may be widened to increase the capacity of the system at a given water surface elevation. The unit is designed to meet project specific hydraulic requirements.

Performance

Full-Scale Laboratory Test Results

A full-scale CDS system (Model CDS2020-5B) was tested at the facility of University of Florida, Gainesville, FL. This CDS unit was evaluated under controlled laboratory conditions of influent flow rate and addition of sediment.

Two different gradations of silica sand material (UF Sediment & OK-110) were used in the CDS performance evaluation. The particle size distributions (PSDs) of the test materials were analyzed using standard method "Gradation ASTM D-422 "Standard Test Method for Particle-Size Analysis of Soils" by a certified laboratory.

UF Sediment is a mixture of three different products produced by the U.S. Silica Company: "Sil-Co-Sil 106", "#1 DRY" and "20/40 Oil Frac". Particle size distribution analysis shows that the UF Sediment has a very fine gradation ($d_{50} = 20$ to $30 \mu\text{m}$) covering a wide size range (Coefficient of Uniformity, C averaged at 10.6). In comparison with the hypothetical TSS gradation specified in the NJDEP (New Jersey Department of Environmental Protection) and NJCAT (New Jersey Corporation for Advanced Technology) protocol for lab testing, the UF Sediment covers a similar range of particle size but with a finer d_{50} (d_{50} for NJDEP is approximately $50 \mu\text{m}$) (NJDEP, 2003).

The OK-110 silica sand is a commercial product of U.S. Silica Sand. The particle size distribution analysis of this material, also included in Figure 1, shows that 99.9% of the OK-110 sand is finer than 250 microns, with a mean particle size (d_{50}) of 106 microns. The PSDs for the test material are shown in Figure 1.

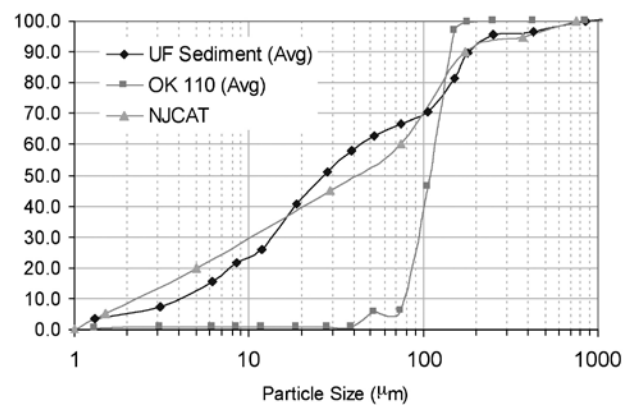

Figure 1. Particle size distributions

Tests were conducted to quantify the performance of a specific CDS unit (1.1 cfs (31.3-L/s) design capacity) at various flow rates, ranging from 1% up to 125% of the treatment design capacity of the unit, using the 2400 micron screen. All tests were conducted with controlled influent concentrations of approximately 200 mg/L. Effluent samples were taken at equal time intervals across the entire duration of each test run. These samples were then processed with a Dekaport Cone sample splitter to obtain representative sub-samples for Suspended Sediment Concentration (SSC) testing using ASTM D3977-97 "Standard Test Methods for Determining Sediment Concentration in Water Samples", and particle size distribution analysis.

Results and Modeling

Based on the data from the University of Florida, a performance model was developed for the CDS system. A regression analysis was used to develop a fitting curve representative of the scattered data points at various design flow rates. This model, which demonstrated good agreement with the laboratory data, can then be used to predict CDS system performance with respect

to SSC removal for any particle size gradation, assuming the particles are inorganic sandy-silt. Figure 2 shows CDS predictive performance for two typical particle size gradations (NJCAT gradation and OK-110 sand) as a function of operating rate.

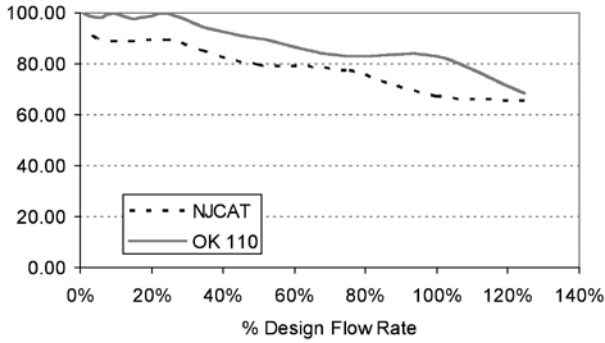

Figure 2. CDS stormwater treatment predictive performance for various particle gradations as a function of operating rate.

Many regulatory jurisdictions set a performance standard for hydrodynamic devices by stating that the devices shall be capable of achieving an 80% removal efficiency for particles having a mean particle size (d_{50}) of 125 microns (e.g. Washington State Department of Ecology — WASDOE - 2008). The model can be used to calculate the expected performance of such a PSD (shown in Figure 3). The model indicates (Figure 4) that the CDS system with 2400 micron screen achieves approximately 80% removal at the design (100%) flow rate, for this particle size distribution ($d_{50} = 125 \mu\text{m}$).

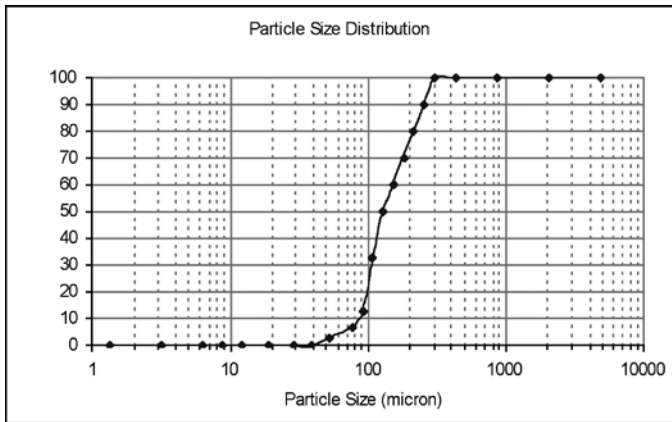

Figure 3. WASDOE PSD

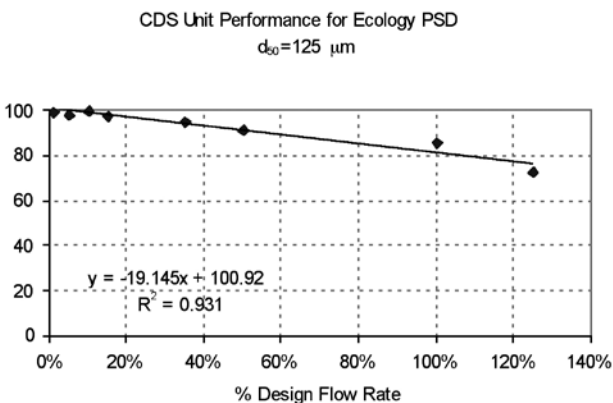

Figure 4. Modeled performance for WASDOE PSD.

Maintenance

The CDS system should be inspected at regular intervals and maintained when necessary to ensure optimum performance. The rate at which the system collects pollutants will depend more heavily on site activities than the size of the unit. For example, unstable soils or heavy winter sanding will cause the grit chamber to fill more quickly but regular sweeping of paved surfaces will slow accumulation.

Inspection

Inspection is the key to effective maintenance and is easily performed. Pollutant transport and deposition may vary from year to year and regular inspections will help ensure that the system is cleaned out at the appropriate time. At a minimum, inspections should be performed twice per year (e.g. spring and fall) however more frequent inspections may be necessary in climates where winter sanding operations may lead to rapid accumulations, or in equipment washdown areas. Installations should also be inspected more frequently where excessive amounts of trash are expected.

The visual inspection should ascertain that the system components are in working order and that there are no blockages or obstructions in the inlet and separation screen. The inspection should also quantify the accumulation of hydrocarbons, trash, and sediment in the system. Measuring pollutant accumulation can be done with a calibrated dipstick, tape measure or other measuring instrument. If absorbent material is used for enhanced removal of hydrocarbons, the level of discoloration of the sorbent material should also be identified



during inspection. It is useful and often required as part of an operating permit to keep a record of each inspection. A simple form for doing so is provided.

Access to the CDS unit is typically achieved through two manhole access covers. One opening allows for inspection and cleanout of the separation chamber (cylinder and screen) and isolated sump. The other allows for inspection and cleanout of sediment captured and retained outside the screen. For deep units, a single manhole access point would allow both sump cleanout and access outside the screen.

The CDS system should be cleaned when the level of sediment has reached 75% of capacity in the isolated sump or when an appreciable level of hydrocarbons and trash has accumulated. If absorbent material is used, it should be replaced when significant discoloration has occurred. Performance will not be impacted until 100% of the sump capacity is exceeded however it is recommended that the system be cleaned prior to that for easier removal of sediment. The level of sediment is easily determined by measuring from finished grade down to the top of the sediment pile. To avoid underestimating the level of sediment in the chamber, the measuring device must be lowered to the top of the sediment pile carefully. Particles at the top of the pile typically offer less resistance to the end of the rod than consolidated particles toward the bottom of the pile. Once this measurement is recorded, it should be compared to the as-built drawing for the unit to determine whether the height of the sediment pile off the bottom of the sump floor exceeds 75% of the total height of isolated sump.

Cleaning

Cleaning of a CDS system should be done during dry weather conditions when no flow is entering the system. The use of a vacuum truck is generally the most effective and convenient method of removing pollutants from the system. Simply remove the manhole covers and insert the vacuum hose into the sump. The system should be completely drained down and the sump fully evacuated of sediment. The area outside the screen should also be cleaned out if pollutant build-up exists in this area.

In installations where the risk of petroleum spills is small, liquid contaminants may not accumulate as quickly as sediment. However, the system should be cleaned out immediately in the event of an oil or gasoline spill. Motor oil and other hydrocarbons that accumulate on a more routine basis should be removed when an appreciable layer has been captured. To remove these pollutants, it may be preferable to use absorbent pads since they are usually less expensive to dispose than the oil/water emulsion that may be created by vacuuming the oily layer. Trash and debris can be netted out to separate it from the other pollutants. The screen should be cleaned to ensure it is free of trash and debris.

Manhole covers should be securely seated following cleaning activities to prevent leakage of runoff into the system from above and also to ensure that proper safety precautions have been followed. Confined space entry procedures need to be followed if physical access is required. Disposal of all material removed from the CDS system should be done in accordance with local regulations. In many jurisdictions, disposal of the sediments may be handled in the same manner as the disposal of sediments removed from catch basins or deep sump manholes. Check your local regulations for specific requirements on disposal.



CDS Model	Diameter		Distance from Water Surface to Top of Sediment Pile		Sediment Storage Capacity	
	ft	m	ft	m	y ³	m ³
CDS1515	3	0.9	3.0	0.9	0.5	0.4
CDS2015	4	1.2	3.0	0.9	0.9	0.7
CDS2015	5	1.5	3.0	0.9	1.3	1.0
CDS2020	5	1.5	3.5	1.1	1.3	1.0
CDS2025	5	1.5	4.0	1.2	1.3	1.0
CDS3020	6	1.8	4.0	1.2	2.1	1.6
CDS3025	6	1.8	4.0	1.2	2.1	1.6
CDS3030	6	1.8	4.6	1.4	2.1	1.6
CDS3035	6	1.8	5.0	1.5	2.1	1.6
CDS4030	8	2.4	4.6	1.4	5.6	4.3
CDS4040	8	2.4	5.7	1.7	5.6	4.3
CDS4045	8	2.4	6.2	1.9	5.6	4.3
CDS5640	10	3.0	6.3	1.9	8.7	6.7
CDS5653	10	3.0	7.7	2.3	8.7	6.7
CDS5668	10	3.0	9.3	2.8	8.7	6.7
CDS5678	10	3.0	10.3	3.1	8.7	6.7

Table 1: CDS Maintenance Indicators and Sediment Storage Capacities

Note: To avoid underestimating the volume of sediment in the chamber, carefully lower the measuring device to the top of the sediment pile. Finer silty particles at the top of the pile may be more difficult to feel with a measuring stick. These finer particles typically offer less resistance to the end of the rod than larger particles toward the bottom of the pile.



SUPPORT

- Drawings and specifications are available at www.ContechES.com.
- Site-specific design support is available from our engineers.



800-338-1122

www.ContechES.com

©2017 Contech Engineered Solutions LLC, a QUIKRETE Company

Contech Engineered Solutions provides site solutions for the civil engineering industry. Contech's portfolio includes bridges, drainage, sanitary sewer, earth stabilization and stormwater treatment products. For information on other Contech division offerings, visit www.ContechES.com or call 800.338.1122

NOTHING IN THIS CATALOG SHOULD BE CONSTRUED AS A WARRANTY. APPLICATIONS SUGGESTED HEREIN ARE DESCRIBED ONLY TO HELP READERS MAKE THEIR OWN EVALUATIONS AND DECISIONS, AND ARE NEITHER GUARANTEES NOR WARRANTIES OF SUITABILITY FOR ANY APPLICATION. CONTECH MAKES NO WARRANTY WHATSOEVER, EXPRESS OR IMPLIED, RELATED TO THE APPLICATIONS, MATERIALS, COATINGS, OR PRODUCTS DISCUSSED HEREIN. ALL IMPLIED WARRANTIES OF MERCHANTABILITY AND ALL IMPLIED WARRANTIES OF FITNESS FOR ANY PARTICULAR PURPOSE ARE DISCLAIMED BY CONTECH. SEE CONTECH'S CONDITIONS OF SALE (AVAILABLE AT WWW.CONTECHES.COM/COS) FOR MORE INFORMATION.

The product(s) described may be protected by one or more of the following US patents: 5,322,629; 5,624,576; 5,707,527; 5,759,415; 5,788,848; 5,985,157; 6,027,639; 6,350,374; 6,406,218; 6,641,720; 6,511,595; 6,649,048; 6,991,114; 6,998,038; 7,186,058; 7,296,692; 7,297,266; related foreign patents or other patents pending.

Water Quality Volume and Water Quality Flow Calculations



Computations

Project:	Residences at Bel Mont	Project #	13555.04
Location:	Belmont, Massachusetts	Sheet	1 of 2
Calculated by:	WAS	Date:	31-Aug-21
Checked by:	GB	Date:	20-Sep-21
Title	Sand Filter Sizing Calculations 1P		

Sedimentation Chamber Sizing (Sand Filter #1)

$$A_s = -Q/W \ln(1-E)$$

A_s = sedimentation surface area (ft²)

Q = discharge rate from drainage area (ft³/s) = WQV/24hr

W = particle settling velocity (0.0004 ft/s recommended for silt)

E = sediment removal efficiency (assume 0.9 or 90%)

WQV =	5,390 ft ³	Impervious area = 32,324 sf
Q =	0.062 ft ³ /s	Water Quality depth = 2in
W =	0.0004 ft/s	
E =	0.9	

A_s Required =	359 ft²	Sedimentation Chamber (15'x30' x 83.2%*)
A_s Provided =	374 ft²	* percentage is efficiency of the footprint based on Hydrocad

Filter Bed Sizing (Sand Filter #1)

$$A_f = (WQV \times d) / kt(h+d)$$

A_f = filter bed surface area (ft²)

WQV = water quality volume (ft³)

d = filter bed depth (ft)

k = hydraulic conductivity of filter media (ft/day)

t = time of water quality volume to drain from system (24 hours)

h = average height of water above filter bed during water quality design storm

WQV =	11,400 ft ³	Impervious area = 68,389 sf
d =	2 ft	Water Quality depth = 2in
k =	4 ft/day	
t =	1 day	
h =	1.5 ft	

A_f Required =	1,629 ft²	Filter Bed Dimensions (80'X30' x 83.2%) = 1,997
A_f Provided =	1,997 ft²	* percentage is efficiency of the footprint based on Hydrocad



Computations

Project:	<u>Residences at Bel Mont</u>	Project #	<u>13555.04</u>
Location:	<u>Belmont, Massachusetts</u>	Sheet	<u>2 of 2</u>
Calculated by:	<u>WAS</u>	Date:	<u>31-Aug-21</u>
Checked by:	<u>GB</u>	Date:	<u>20-Sep-21</u>
Title	<u>Sand Filter Sizing Calculations 3P</u>		

Sedimentation Chamber Sizing (Sand Filter #2)

$$A_s = -Q/W \ln(1-E)$$

A_s = sedimentation surface area (ft²)

Q = discharge rate from drainage area (ft³/s) = WQV/24hr

W = particle settling velocity (0.0004 ft/s recommended for silt)

E = sediment removal efficiency (assume 0.9 or 90%)

WQV =	3,400 ft ³	Impervious area =	20,090 sf
Q =	0.039 ft ³ /s	Water Quality depth =	2in
W =	0.0004 ft/s		
E =	0.9		

A_s Required = 227 ft²

A_s Provided = 252 ft² Sedimentation Chamber (10'x30.3' X 83.2%*)
 * percentage is efficiency of the footprint based on Hydrocad

Filter Bed Sizing (Sand Filter #2)

$$A_f = (WQV \times d) / kt(h+d)$$

A_f = filter bed surface area (ft²)

WQV = water quality volume (ft³)

d = filter bed depth (ft)

k = hydraulic conductivity of filter media (ft/day)

t = time of water quality volume to drain from system (24 hours)

h = average height of water above filter bed during water quality design storm

WQV =	8,030 ft ³	Impervious area =	48,177 sf
d =	2 ft	Water Quality depth =	2in
k =	4 ft/day		
t =	1 day		
h =	1.5 ft		

A_f Required = 1,147 ft² Filter Bed Dimensions (65'X30.3' X 83.2%) = 1638 sf

A_f Provided = 1,638 ft² * percentage is efficiency of the footprint based on Hydrocad



101 Walnut Street
 Post Office Box 9151
 Watertown, MA 02471
 P 617.924.1770

Water Quality Flow Conversion

Name: Residences at Bel Mont
 Belmont, MA

Proj. No.: **13555.04**
 Date: **4/12/2021**
 Computed by: **JRB**
 Revised by: **GB**
 Revised date: **9/9/21**

MaDEP Standard Method to Convert Required Water Quality Volume to a Discharge Rate

Water Quality Unit	Impervious Area (sf)	Impervious Area (mi ²)	WQV (inches)	Tc		qu (csm/in)	Q (cfs)	Q (gpm)
				(min)	(hrs)			
Stormfilter #1	86,250	0.0031	0.5	6.0	0.100	752	1.16	521.14
Stormfilter #2	89,735	0.0032	0.5	6.0	0.100	752	1.21	542.20

Water Quality Flow (WQF) = Q = (qu) (A) (WQV)

Where: qu = the unit peak discharge (in csm/in)
 A = impervious surface drainage area (in square miles)
 WQV = water quality volume (in inches)

Provided: Stormfilter 1: 28 cartridges required (521.14 gpm/18.79 gpm per cartridge)
 Stormfilter 2: 29 cartridges required (542.2 gpm/18.79 gpm per cartridge)

- Notes:
1. Refer to MaDEP Standard Method to Convert Required Water Quality Volume to a Discharge Rate for Sizing Flow Based Manufactured Proprietary



Sand Filter Drawdown Calculations

Project	Residences at Bel Mont	Project #	13555.04
Calculated by	GB	Date	9.23.2021
Checked by		Date	

PROVIDED RECHARGE VOLUME			
<u>Sand Filter 1 (1P):</u>			
Volume provided below outlet		195.30	
Provided Volume:	Bottom Area	Volume	
	(ft ²)	(ft ³)	
	1,996	7,821	
Drawdown:	$(V_{\text{Infiltration}}/A_{\text{Bottom}})/\text{Rawl's Rate}$		
Handbook recharge for sandf filters = 2	---	(in/hr)	
Drawdown Time:	24	(hours)	
<u>Sand Filter 2 (3p):</u>			
Volume provided below outlet		174.0	
Provided Volume:	Bottom Area	Volume	
	(ft ²)	(ft ³)	
	1,638	6,564	
Drawdown:	$(V_{\text{Infiltration}}/A_{\text{Bottom}})/\text{Rawl's Rate}$		
Handbook recharge for sandf filters = 2	---	(in/hr)	
Drawdown Time:	24	(hours)	

TSS Removal Worksheets



VHB, Inc.
 101 Walnut Street
 Post Office Box 9151
 Watertown, MA 02471
 P 617.924.1770

TSS Removal Calculation Worksheet

Project Name: **Residences at Bel Mont**
 Project Number: **1355.04**
 Location: **Belmont, MA**
 Discharge Point: **DP-1, DP-3**
 Drainage Area(s): **PR-5, PR-7, PR-9, PR-12**

Sheet: **2 of 2**
 Date: **8-Sep-2021**
 Computed by: **WAS**
 Checked by: _____

A	B	C	D	E
BMP*	TSS Removal Rate*	Starting TSS Load**	Amount Removed (C*D)	Remaining Load (D-E)
Deep Sump and Hooded Catch Basin	25%	1.00	0.25	0.75
Sand Filter	80%	0.75	0.60	0.15
	0%	0.15	0.00	0.15
	0%	0.15	0.00	0.15
	0%	0.15	0.00	0.15

* BMP and TSS Removal Rate Values from the MassDEP Stormwater Handbook Vol. 1. Removal rates for proprietary devices will be sized by the manufacturer to achieve a minimum of 90% TSS removal

** Equals remaining load from previous BMP (E)

***StormFilter sizing calculations gives a TSS removal rate of 90.5%. To be conservative, 80% removal is used for this calculation.

**Treatment Train
 TSS Removal =**

85%



VHB, Inc.
 101 Walnut Street
 Post Office Box 9151
 Watertown, MA 02471
 (617) 924-1770

TSS Removal Calculation Worksheet

Project Name: **Residences at Bel Mont**
 Project Number: **13555.04**
 Location: **Belmont MA**
 Discharge Point: **DP-1, DP-3**
 Drainage Area(s): **PR-3, PR-4, PR-10, PR-13, PR-14**

Sheet: **1 of 2**
 Date: **14-Apr-2021**
 Computed by: **JRB**
 Checked by: _____
 Revised Date: **8-Sep-21**
 Revised by: **WAS**

A	B	C	D	E
BMP*	TSS Removal Rate*	Starting TSS Load**	Amount Removed (C*D)	Remaining Load (D-E)
Deep Sump and Hooded Catch Basin	25%	1.00	0.25	0.75
StormFilter***	80%	0.75	0.60	0.15
	0%	0.15	0.00	0.15
	0%	0.15	0.00	0.15
	0%	0.15	0.00	0.15

**Treatment Train
 TSS Removal =**

85%

* BMP and TSS Removal Rate Values from the MassDEP Stormwater Handbook Vol. 1. Removal rates for proprietary devices will be sized by the manufacturer to achieve a minimum of 90% TSS removal

** Equals remaining load from previous BMP (E)

***StormFilter sizing calculations gives a TSS removal rate of 90.5%. To be conservative, 80% removal is used for this calculation.

Appendix E: Standard 8 Supporting Information

- › List of recommended Construction Period BMPs
- › Recommended construction period maintenance checklist

Recommended Construction Period Pollution Prevention and Erosion and Sedimentation Controls

Erosion and Sedimentation Control Measures

The following erosion and sedimentation controls are for use during the earthwork and construction phases of the project. The following controls are provided as recommendations for the site contractor and do not constitute or replace the final Stormwater Pollution Prevention Plan that must be fully implemented by the Contractor and owner in Compliance with EPA NPDES regulations.

Siltsock

Filter socks filled with compost will be placed to trap sediment transported by runoff before it reaches the drainage system or leaves the construction site.

Silt Fencing

In areas where high runoff velocities or high sediment loads are expected, hay bale barriers will be backed up with silt fencing. This semi-permeable barrier made of a synthetic porous fabric will provide additional protection. The silt fences and hay bale barrier will be replaced as determined by periodic field inspections.

Catch Basin Protection

Newly constructed and existing catch basins will be protected with hay bale barriers (where appropriate) or silt sacks throughout construction.

Gravel and Construction Entrance/Exit

A temporary crushed-stone construction entrance/exit will be constructed. A cross slope will be placed in the entrance to direct runoff to a protected catch basin inlet or settling area. If deemed necessary after construction begins, a wash pad may be included to wash off vehicle wheels before leaving the project site.

Diversion Channels

Diversion channels will be used to collect runoff from construction areas and discharge to either sedimentation basins or protected catch basin inlets.

Temporary Sediment Basins

Temporary sediment basins will be designed either as excavations or bermed stormwater detention structures (depending on grading) that will retain runoff for a sufficient period of time to allow suspended soil particles to settle out prior to

discharge. These temporary basins will be located based on construction needs as determined by the contractor and outlet devices will be designed to control velocity and sediment. Points of discharge from sediment basins will be stabilized to minimize erosion.

Vegetative Slope Stabilization

Stabilization of open soil surfaces will be implemented within 14 days after grading or construction activities have temporarily or permanently ceased, unless there is sufficient snow cover to prohibit implementation. Vegetative slope stabilization will be used to minimize erosion on slopes of 3:1 or flatter. Annual grasses, such as annual rye, will be used to ensure rapid germination and production of root mass. Permanent stabilization will be completed with the planting of perennial grasses or legumes. Establishment of temporary and permanent vegetative cover may be established by hydro-seeding or sodding. A suitable topsoil, good seedbed preparation, and adequate lime, fertilizer and water will be provided for effective establishment of these vegetative stabilization methods. Mulch will also be used after permanent seeding to protect soil from the impact of falling rain and to increase the capacity of the soil to absorb water.

Maintenance

- The contractor or subcontractor will be responsible for implementing each control shown on the Sedimentation and Erosion Control Plan. In accordance with EPA regulations, the contractor must sign a copy of a certification to verify that a plan has been prepared and that permit regulations are understood.
- The on-site contractor will inspect all sediment and erosion control structures periodically and after each rainfall event. Records of the inspections will be prepared and maintained on-site by the contractor.
- Silt shall be removed from behind barriers if greater than 6-inches deep or as needed.
- Damaged or deteriorated items will be repaired immediately after identification.
- The underside of hay bales should be kept in close contact with the earth and reset as necessary.
- Sediment that is collected in structures shall be disposed of properly and covered if stored on-site.
- Erosion control structures shall remain in place until all disturbed earth has been securely stabilized. After removal of structures, disturbed areas shall be regraded and stabilized as necessary.

**Residences at Bel Mont, Belmont Massachusetts
Construction Best Management Practices – Maintenance/ Evaluation Checklist**

Best Management Practice	Inspection Frequency	Date Inspected	Inspector	Minimum Maintenance and Key Items to Check	Cleaning/Repair Needed (List Items)	Date of Cleaning/Repair	Performed by:
Erosion Control Barriers/Silt Fencing	Weekly and after ½” storm events or greater			Inspect for deterioration or failure. Remove sediment as necessary.	<input type="checkbox"/> yes <input type="checkbox"/> no		
Silt Sack Catch Basin Protection	Weekly and after ½” storm events or greater			Inspect for proper operation of catch basin. If clogged, dispose of sediment.	<input type="checkbox"/> yes <input type="checkbox"/> no		
Gravel and Construction Entrance/Exit	Weekly and after ½” storm events or greater			Inspect for breakdown of crushed-stone. Reapply stone if necessary to depths specified in construction documents.	<input type="checkbox"/> yes <input type="checkbox"/> no		
Vegetative Slope Stabilization	Weekly and after ½” storm events or greater			Inspect for erosion. Correct if necessary.	<input type="checkbox"/> yes <input type="checkbox"/> no		
Temporary Sediment Basins	Weekly and after ½” storm events or greater			Inspect for proper function. Correct if necessary.	<input type="checkbox"/> yes <input type="checkbox"/> no		
					<input type="checkbox"/> yes <input type="checkbox"/> no		

Stormwater Control Manager _____

Appendix F: Local Compliance

- › Phosphorous Removal Calculations
- › Town of Belmont Stormwater Checklist

Phosphorous Removal Calculations



Project: Mclean Zone 3	Project # 13555.04
Location: Belmont, MA	Sheet 1 of 1
Calculated by: WAS	Date: 9.8.21
Checked by: GB	Date: 9.9.21
Title Phosphorous Removal	

Phosphorous Removal Rates		
BMP	Removal Rate*	Notes
Sand Filter	63%	2.0 inch WQV
Contech Stormfilter	82%	Per Contech Field Performance Study

*Removal Rate from Appendix F, Attachment 3 of Massachusetts MS4 General Permit

Phosphorous Load Reduction Target: 60% for DP
65%

Phosphorous Loading		
Land Use	Cover Type	PLER (lb/ac/yr)*
Multi-Family and High Density Residential	Impervious	2.32
	Pervious (HSG C)	0.21

* per Table 3-1 in Attachment 3 of Appendix F of MA MS4 General Permit

Proposed Conditions Phosphorous Loading							
Subcatchment	Impervious (ac)	Pervious (ac)	P to BMP (lb/year)	BMP	Removal Rate	Phosphorous after treatment(lb/year)	
PR-1*	0.5	1.1	1.4	-	0%	1.4	lb/year
PR-2	0.1	0.5	0.2	-	0%	0.2	lb/year
PR-3*	2.1	1.3	5.0	2P	82%	0.9	lb/year
PR-4*	1.2	0.9	3.0	4P	82%	0.5	lb/year
PR-5	1.6	0.2	3.7	1P	63%	1.4	lb/year
PR-6	0.3	0.2	0.7	-	0%	0.7	lb/year
PR-7	0.7	0.2	1.6	3P	63%	0.6	lb/year
PR-8	0.0	1.0	0.2	-	0%	0.2	lb/year
PR-9	0.3	0.0	0.6	3P	63%	0.2	lb/year
PR-10*	0.2	0.1	0.5	4P	82%	0.1	lb/year
PR-11	0.0	0.5	0.1	-	0%	0.1	lb/year
PR-12	0.2	0.0	0.4	3P	63%	0.1	lb/year
PR-13*	0.2	0.0	0.6	4P	82%	0.1	lb/year
PR-14*	0.2	0.0	0.6	4P	82%	0.1	lb/year
PR-15*	0.1	0.0	0.2	4P	82%	0.0	lb/year
Total						6.7	lb/year

* - denotes subcatchment draining to Charles River via Beaver Brook

Total (ac) 7.6 5.8

Summary Table - Project Site		
Existing Phosphorous Loading Rate	18.8	lb/year
Proposed Phosphorous Loading Rate	6.7	lb/year
Percent Reduction	64.3%	

Summary Table - Draining to Charles River		
Existing Phosphorous Loading Rate	11.2	lb/year
Proposed Phosphorous Loading Rate	3.1	lb/year
Percent Reduction	72.1%	

The Stormwater Management StormFilter®- PhosphoSorb®

Field Performance Summary

A three year field performance evaluation of The Stormwater Management StormFilter® (StormFilter) with PhosphoSorb® media operating at a specific flow rate of 1.67 gpm/ft² was completed at a 0.06 acre roadway site in Zigzag, Oregon. The Quality Assurance Project Plan (QAPP) for this evaluation followed the Guidance for Evaluating Emerging Stormwater Treatment Technologies: Technology Assessment Protocol – Ecology (TAPE, 2011). The StormFilter with PhosphoSorb Technical Evaluation Report resulted in a General Use Level Designation from Washington State Department of Ecology for Total Suspended Solids (TSS) and Total Phosphorus removal.

Results of the field performance evaluation for 17 qualified events are provided in Table 1.

Table 1. StormFilter with PhosphoSorb Field Evaluation Results

	Parameter	Sample population (n)	Average Influent (mg/L)	Average Effluent (mg/L)	Average Removal (%)	Aggregate Pollutant Load Reduction ¹ (%)
Solids	TSS	17	380	40	88	89
	SSC<500 µm	15	325	40	87	89
	Silt and Clay ²	16	153	32	78	82
Nutrients	Total Phosphorus	17	0.33	0.07	73	82
	Total Nitrogen	17	1.14	0.57	43	50
Metals	Total Zinc	15	0.129	0.024	78	81
	Dissolved Zinc	7	0.016	0.01	28	32
	Total Copper	15	0.026	0.005	79	82
	Dissolved Copper	7	0.004	0.003	30	28
	Total Aluminum	16	5.85	1.08	83	83
	Total Lead	15	0.009	0.003	64	70

Load Reduction
89% TSS
82% Total Phosphorus
50% Total Nitrogen

¹ Treatment Efficiency Calculation, Method #2 (TAPE, 2008)

² Suspended Solids less than 62.5 microns

Data were analyzed using the TAPE bootstrap confidence interval calculator for TSS and Total Phosphorus. The lower 95% confidence interval for TSS removal efficiency was 85%. The lower 95% confidence interval for total phosphorus removal efficiency was 67%. The upper 95% confidence interval for total phosphorus effluent concentration was 0.084 mg/L.

Over the entire 37 month evaluation period, the total effluent volume recorded at the site was 376,244 gallons. A total of 14,060 gallons were bypassed through the system accounting for 4% of the total recorded volume. A total of 26 events contained bypass flow, with 23 of those events producing peak flows exceeding the design treatment capacity of the system. The three events with bypass flows occurring below the design treatment capacity triggered maintenance. During the evaluation period, the system lasted between 10 and 12 months between maintenance events and retained an average of 291 pounds of sediment per maintenance event.

References

Contech Engineered Solutions, LLC. (2015). The Stormwater Management StormFilter® PhosphoSorb® at a Specific Flow Rate of 1.67 gpm/ft² General Use Level Designation Technical Evaluation Report. Portland, OR. Author.

Washington State Department of Ecology (Ecology). (2011). Guidance for Evaluating Emerging Stormwater Treatment Technologies: Technology Assessment Protocol – Ecology (TAPE). Olympia, Washington. (Referred to as TAPE, 2011)

Washington State Department of Ecology (Ecology). (2008). Guidance for Evaluating Emerging Stormwater Treatment Technologies: Technology Assessment Protocol – Ecology (TAPE). Olympia, Washington. (Referred to as TAPE, 2008)

Town of Belmont Stormwater Checklist



TOWN OF BELMONT

Checklist for Stormwater Management and Erosion Control Report

A. Introduction

Important: When filling out forms on the computer, use only the tab key to move your cursor - do not use the return key.



A Stormwater Management and Erosion Control Report must be submitted with the building permit application for a project that is covered by the Town of Belmont Stormwater Management and Erosion Control Bylaw. The following checklist is NOT a substitute for the Report (which should provide more substantive and detailed information) but is offered here as a tool to help the applicant organize their Stormwater Management and Erosion Control documentation for their Report and for the reviewer to assess this information in a consistent format. As noted in the Checklist, the Report must contain the engineering computations and supporting information set forth in Volume 3 of the [Massachusetts Stormwater Handbook](#). The Stormwater Report must be prepared and certified by a Registered Professional Engineer (RPE) licensed in the Commonwealth.

The Report must include:

- The Checklist completed and stamped by a Registered Professional Engineer (see page 2) that certifies that the Report contains all required submittals.¹ This Checklist is to be used as the cover for the completed Report.
- Applicant/Project Name
- Project Address
- Name of Firm and Registered Professional Engineer that prepared the Report
- Long-Term Pollution Prevention Plan required by Standards 4-6
- Construction Period Pollution Prevention and Erosion and Sedimentation Control Plan required by Standard 8²
- Operation and Maintenance Plan required by Standard 9

In addition to all plans and supporting information, the Report must include a brief narrative describing stormwater management practices, including environmentally sensitive site design and LID techniques, along with a diagram depicting runoff through the proposed BMP treatment train. Plans are required to show existing and proposed conditions, identify all wetland resource areas, NRCS soil types, critical areas, Land Uses with Higher Potential Pollutant Loads (LUHPPL), and any areas on the site where infiltration rate is greater than 2.4 inches per hour. The Plans shall identify the drainage areas for both existing and proposed conditions at a scale that enables verification of supporting calculations.

As noted in the Checklist, the Report shall document compliance with each of the Stormwater Management Standards as provided in the Massachusetts Stormwater Handbook. The soils evaluation and calculations shall be done using the methodologies set forth in Volume 3 of the Massachusetts Stormwater Handbook. The Report shall also document compliance with the Stormwater Management and Erosion Control Bylaw recognizing the bylaw contains provisions that could be more strict or broader in scope than the Stormwater Management Standards.

To ensure that the Report is complete, applicants are required to fill in the Report Checklist by checking the box to indicate that the specified information has been included in the Report. If any of the information specified in the checklist has not been submitted, the applicant must provide an explanation. The completed Stormwater Management and Erosion Control Checklist and Certification must be

¹ The Stormwater Report may also include the Illicit Discharge Compliance Statement required by Standard 10. If not included in the Stormwater Report, the Illicit Discharge Compliance Statement must be submitted prior to the discharge of stormwater runoff to the post-construction best management practices.

² For some complex projects, it may not be possible to include the Construction Period Erosion and Sedimentation Control Plan in the Stormwater Report. In that event, the issuing authority has the discretion to issue a permit that approves the project and includes a condition requiring the proponent to submit the Construction Period Erosion and Sedimentation Control Plan before commencing any land disturbance activity on the site.



TOWN OF BELMONT

Checklist for Stormwater Management and Erosion Control Report

B. Report Checklist and Certification

The following checklist is intended to serve as a guide for applicants as to the elements that ordinarily need to be addressed in a complete Report. The checklist is also intended to provide the reviewing authority with a summary of the components necessary for a comprehensive Report that addresses the ten Stormwater Standards.

Note: Because stormwater requirements vary from project to project, it is possible that a complete Report may not include information on some of the subjects specified in the Checklist. If it is determined that a specific item does not apply to the project under review, please note that the item is not applicable (N.A.) and provide the reasons for that determination.

A complete checklist must include the Certification set forth below signed by the Registered Professional Engineer who prepared the Report.

Registered Professional Engineer's Certification

I have reviewed the Stormwater Management and Erosion Control Report, including the soil evaluation, computations, Long-term Pollution Prevention Plan, the Construction Period Erosion and Sedimentation Control Plan, the Long-term Post-Construction Operation and Maintenance Plan, the Illicit Discharge Compliance Statement (if included) and the plans showing the stormwater management system, and have determined that they have been prepared in accordance with the requirements of the Stormwater Management Standards as further elaborated by the Massachusetts Stormwater Handbook. I have also determined that the information presented in the Stormwater Checklist is accurate and that the information presented in the Stormwater Report accurately reflects conditions at the site as of the date of this permit application.

Registered Professional Engineer Block and Signature



 9/23/2021

Signature and Date



TOWN OF BELMONT

Checklist for Stormwater Management and Erosion Control Report

60-325 - Stormwater Management and Erosion Control Bylaw (excerpt)

F Stormwater Management and Erosion Control

F (1) Regulated Activities

A Stormwater Management and Erosion Control Permit shall be required prior to undertaking any land disturbance that involves:

- (a) An alteration that will result in land disturbances of 2,500 square feet of total area or more, or that is part of a common plan for development that will disturb 2,500 square feet or more;
- (b) An alteration that will increase the amount of a lot's impervious surface area to more than 25% of the lot's total area; or
- (c) Storage or permanent placement of more than 100 cubic yards of excavated material, fill, snow or ice.

F (3) General Requirements

(a) An Operation and Maintenance Plan shall be submitted to the OCD for approval prior to the issuance of a Stormwater Management and Erosion Control Permit. The Operation and Maintenance Plan shall be designed to ensure compliance with the Stormwater Management and Erosion Control Permit, this Bylaw, and the Massachusetts Surface Water Quality Standards, 314 CMR 4.00, in all seasons and throughout the life of the system.

(b) As-built drawings showing all stormwater management systems shall be submitted to the OCD at the completion of a project.

(c) The OCD may require the applicant to contribute to the cost of design, construction, and maintenance of a public or shared stormwater facility in lieu of an onsite stormwater facility where the OCD determines that there are not sufficient site conditions for onsite Best Management Practices that will satisfy the design criteria set forth in Section 34.6.4.1 of this Bylaw and the performance standards set forth in the regulations promulgated under this Bylaw. Funds so contributed may be used to design, construct, and maintain stormwater projects that will improve the quality and quantity of surface waters in Belmont by treating and recharging stormwater from existing impervious surfaces that is now discharged to said waters with inadequate treatment or recharge. The amount of any required contribution to the fund shall be determined by the OCD pursuant to standards established in the Regulations adopted pursuant to this Bylaw.

F (4) Design Criteria (The Report shall consider all of the design criteria below)

All Development shall satisfy the following design criteria:

- (a) Compliance with all applicable provisions of the Stormwater Management Standards, regardless of the proximity of the development to resource areas or their buffer zones, as defined by the *Wetlands Protection Act, M.G.L. c. 131, § 40* and its implementing regulations.
- (b) Erosion and sediment controls must be implemented to prevent adverse impacts during disturbance and construction activities.
- (c) There shall be no change to the existing conditions of abutting properties from any increase in volume of stormwater runoff or from erosion, silting, flooding, sedimentation or impacts to wetlands, ground water levels or wells.
- (d) When any proposed discharge may have an impact upon streams, wetlands and/or storm sewers, the OCD may require minimization or elimination of this impact based on site conditions and existing stormwater system capacity.



TOWN OF BELMONT

Checklist for Stormwater Management and Erosion Control Report

Checklist

Project Type: Is the application for new development, redevelopment, or a mix of new and redevelopment?

- New development
- Redevelopment
- Mix of New Development and Redevelopment

LID Measures: Stormwater Standards require LID measures to be considered. Document what environmentally sensitive design and LID Techniques were considered during the planning and design of the project:

- No disturbance to any Wetland Resource Areas
- Site Design Practices
- Reduced Impervious Area (Redevelopment Only)
- Minimizing disturbance to existing trees and shrubs
- LID Site Design Credit Requested:
 - Credit 1
 - Credit 2
 - Credit 3
- Use of "country drainage" versus curb and gutter conveyance and pipe
- Bioretention Cells (includes Rain Gardens)
- Constructed Stormwater Wetlands (includes Gravel Wetlands designs)
- Treebox Filter
- Water Quality Swale
- Grass Channel
- Green Roof
- Other (describe): _____

Standard 1: No New Untreated Discharges

- No new untreated discharges
- Outlets have been designed so there is no erosion or scour to wetlands and waters of the Commonwealth



TOWN OF BELMONT

Checklist for Stormwater Management and Erosion Control Report

- Supporting calculations specified in Volume 3 of the Massachusetts Stormwater Handbook included.

Standard 2: Peak Rate Attenuation

- Standard 2 waiver requested because the project is located in land subject to coastal storm flowage and stormwater discharge is to a wetland subject to coastal flooding.
- Evaluation provided to determine whether off-site flooding increases during the 100-year 24-hour storm.
- Calculations provided to show that post-development peak discharge rates do not exceed pre-development rates for the 2-year and 10-year 24-hour storms. If evaluation shows that off-site flooding increases during the 100-year 24-hour storm, calculations are also provided to show that post-development peak discharge rates do not exceed pre-development rates for the 100-year 24-hour storm.
- Any potential change to the existing conditions of abutting properties from any increase in volume of stormwater runoff have been identified in the Report
- The Report provides calculations demonstrating that the post-development discharge volume is equal to or less than the pre-development discharge volume from the 2-year and the 10-year 24-hour storms.
- The Report provides a quantitative impact of discharge volumes from the 100-year 24-hour storm. If this evaluation shows that increased off-site flooding result from the discharge volumes from the 100-year 24-hour storms, BMPs also are described in the Report that the applicant will implement and maintained to attenuate these discharges.
- Any potential change to the existing conditions of abutting properties from erosion, silting, flooding, or sedimentation have been identified in the Report.
- The Report describes the practices and controls that the Applicant will implement and maintain to prevent adverse impacts from erosion, silting, flooding, or sedimentation.
- Any potential impacts to wetlands have been identified in the Report. **None anticipated**
- The Report describes the practices and controls that the Applicant will implement and maintain to prevent adverse impacts to wetlands.

Additional Requirements for Projects other than One and Two Family Developments:

- Any potential impacts to ground water levels or wells have been identified in the Report, including quantitative projections of changes in the seasonal high water table and quantitative projections of storm-related short-term mounding calculations associated with infiltration BMPs for a 24-hour 10 year design storm. **None anticipated**
- The Report describes the practices and controls that the Applicant will implement and maintain (if required) to prevent adverse impacts to ground water levels or wells for a 24-hour 10 year design storm.

Requirements Specific to Section F (4)(d)

- Is stormwater from the pre-development site discharged directly to (check all that apply):



TOWN OF BELMONT

Checklist for Stormwater Management and Erosion Control Report

-
- A surface water body (specify the water body)
 - The Belmont MS4 (storm sewers)
 - Another MS4 (specify the MS4)
 - Other (specify)
 - Will stormwater from the post-development site be discharges directly to (check all that apply):
 - A surface water body (specify the water body)
 - The Belmont MS4 (storm sewers)
 - Another MS4 (specify the MS4)
 - Other (specify)
 - Any potential impacts upon streams, wetlands and/or storm sewers have been identified in the Report. (Explain in Report narrative) **None anticipated**
 - These will be prevented with mitigating measures that the Applicant will implement and maintain (explain in Report narrative)
 - These will be prevented without mitigating measures (explain in Report narrative)
 - The Report describes the practices and controls that the Applicant will implement and maintain to prevent any adverse impacts to streams, wetlands and/or storm sewers. **None anticipated**

Additional Requirements for Projects other than One and Two Family Developments:

- If the discharge is to an MS4, a certification that the discharge meets Massachusetts Surface Water Quality Standards and any applicable approved Total Maximum Daily Load (TMDL) waste load allocation is included in the Report.

Standard 3: Recharge

- Soil Analysis provided.
- Required Recharge Volume calculation provided.
- Required Recharge volume reduced through use of the LID site Design Credits.
- Sizing the infiltration, BMPs is based on the following method: Check the method used.
 - Static
 - Simple Dynamic
 - Dynamic Field¹
- Runoff from all impervious areas at the site discharging to the infiltration BMP.
- Runoff from all impervious areas at the site is *not* discharging to the infiltration BMP and calculations are provided showing that the drainage area contributing runoff to the infiltration BMPs is sufficient to generate the required recharge volume.
- Recharge BMPs have been sized to infiltrate the Required Recharge Volume.



TOWN OF BELMONT

Checklist for Stormwater Management and Erosion Control Report

- Recharge BMPs have been sized to infiltrate the Required Recharge Volume *only* to the maximum extent practicable for the following reason:
 - Site is comprised solely of C and D soils and/or bedrock at the land surface
 - M.G.L. c. 21E sites pursuant to 310 CMR 40.0000
 - Solid Waste Landfill pursuant to 310 CMR 19.000
 - Project is otherwise subject to Stormwater Management Standards only to the maximum extent practicable.
 - Calculations showing that the infiltration BMPs will drain in 72 hours are provided.
 - Property includes a M.G.L. c. 21E site or a solid waste landfill and a mounding analysis is included.
- ¹ 80% TSS removal is required prior to discharge to infiltration BMP if Dynamic Field method is used.
- The infiltration BMP is used to attenuate peak flows during storms greater than or equal to the 10-year 24-hour storm and separation to seasonal high groundwater is less than 4 feet and a mounding analysis is provided.
 - Documentation is provided showing that infiltration BMPs do not adversely impact nearby wetland

Standard 4: Water Quality

The Long-Term Pollution Prevention Plan typically includes the following:

- Good housekeeping practices;
 - Provisions for storing materials and waste products inside or under cover;
 - Vehicle washing controls;
 - Requirements for routine inspections and maintenance of stormwater BMPs;
 - Spill prevention and response plans;
 - Provisions for maintenance of lawns, gardens, and other landscaped areas;
 - Requirements for storage and use of fertilizers, herbicides, and pesticides;
 - Pet waste management provisions;
 - Provisions for operation and management of septic systems;
 - Provisions for solid waste management;
 - Snow disposal and plowing plans relative to Wetland Resource Areas;
 - Winter Road Salt and/or Sand Use and Storage restrictions;
 - Street sweeping schedules;
 - Provisions for prevention of illicit discharges to the stormwater management system;
 - Documentation that Stormwater BMPs are designed to provide for shutdown and containment in the event of a spill or discharges to or near critical areas or from LUHPPL;
 - Training for staff or personnel involved with implementing Long-Term Pollution Prevention Plan;
 - List of Emergency contacts for implementing Long-Term Pollution Prevention Plan.
- A Long-Term Pollution Prevention Plan is attached to Stormwater Report and is included as an attachment to the Wetlands Notice of Intent. 0.5"
 - Treatment BMPs subject to the 44% TSS removal pretreatment requirement and the ~~one~~ 0.5" inch rule for calculating the water quality volume are included, and discharge:
 - is within the Zone II or Interim Wellhead Protection Area
 - is near or to other critical areas
 - is within soils with a rapid infiltration rate (greater than 2.4 inches per hour)



TOWN OF BELMONT

Checklist for Stormwater Management and Erosion Control Report

- involves runoff from land uses with higher potential pollutant loads.
- The Required Water Quality Volume is reduced through use of the LID site Design Credits.
- Calculations documenting that the treatment train meets the 80% TSS removal requirement and, if applicable, the 44% TSS removal pretreatment requirement, are provided.
- The BMP is sized (and calculations provided) based on:
 - The ½" or 1" Water Quality Volume or
 - The equivalent flow rate associated with the Water Quality Volume and documentation is provided showing that the BMP treats the required water quality volume.
- The applicant proposes to use proprietary BMPs, and documentation supporting use of proprietary BMP and proposed TSS removal rate is provided. This documentation may be in the form of the propriety BMP checklist found in Volume 2, Chapter 4 of the Massachusetts Stormwater Handbook and submitting copies of the TARP Report, STEP Report, and/or other third party studies verifying performance of the proprietary BMPs.
- A TMDL exists that indicates a need to reduce pollutants other than TSS and documentation showing that the BMPs selected are consistent with the TMDL is provided.

Standard 5: Land Uses With Higher Potential Pollutant Loads (LUHPPLs) **Not Applicable**

- The NPDES Multi-Sector General Permit covers the land use and the Stormwater Pollution Prevention Plan (SWPPP) has been included with the Stormwater Report.
- The NPDES Multi-Sector General Permit covers the land use and the SWPPP will be submitted **prior to** the discharge of stormwater to the post-construction stormwater BMPs.
- The NPDES Multi-Sector General Permit does **not** cover the land use.
- LUHPPLs are located at the site and industry specific source control and pollution prevention measures have been proposed to reduce or eliminate the exposure of LUHPPLs to rain, snow, snow melt and runoff, and been included in the long term Pollution Prevention Plan.
- All exposure has been eliminated.
- All exposure has **not** been eliminated and all BMPs selected are on MassDEP LUHPPL list.
- The LUHPPL has the potential to generate runoff with moderate to higher concentrations of oil and grease (e.g. all parking lots with >1000 vehicle trips per day) and the treatment train includes an oil grit separator, a filtering bioretention area, a sand filter or equivalent.

Standard 6: Critical Areas **Not Applicable**

- The discharge is near or to a critical area and the treatment train includes only BMPs that MassDEP has approved for stormwater discharges to or near that particular class of critical area.
- Critical areas and BMPs are identified in the Stormwater Report.

Standard 7: Redevelopments and Other Projects Subject to the Standards only to the maximum extent practicable **Project meets all stormwater standards**

- The project is subject to the Stormwater Management Standards only to the maximum Extent Practicable as a:
 - Limited Project



TOWN OF BELMONT

Checklist for Stormwater Management and Erosion Control Report

- Small Residential Projects: 5-9 single family houses or 5-9 units in a multi-family development provided there is no discharge that may potentially affect a critical area.
- Small Residential Projects: 2-4 single family houses or 2-4 units in a multi-family development with a discharge to a critical area
- Marina and/or boatyard provided the hull painting, service and maintenance areas are protected from exposure to rain, snow, snow melt and runoff
- Bike Path and/or Foot Path
- Redevelopment Project
- Redevelopment portion of mix of new and redevelopment.
- Certain standards are not fully met (Standard No. 1, 8, 9, and 10 must always be fully met) and an explanation of why these standards are not met is contained in the Stormwater Report.
- The project involves redevelopment and a description of all measures that have been taken to improve existing conditions is provided in the Stormwater Report. The redevelopment checklist found in Volume 2 Chapter 3 of the Massachusetts Stormwater Handbook may be used to document that the proposed stormwater management system (a) complies with Standards 2, 3 and the pretreatment and structural BMP requirements of Standards 4-6 to the maximum extent practicable and (b) improves existing conditions.

Standard 8: Construction Period Pollution Prevention and Erosion and Sedimentation Control

A Construction Period Pollution Prevention and Erosion and Sedimentation Control Plan must include the following information:

- Narrative;
- Construction Period Operation and Maintenance Plan;
- Names of Persons or Entity Responsible for Plan Compliance;
- Construction Period Pollution Prevention Measures;
- Erosion and Sedimentation Control Plan Drawings;
- Detail drawings and specifications for erosion control BMPs, including sizing calculations;
- Vegetation Planning;
- Site Development Plan;
- Construction Sequencing Plan;
- Sequencing of Erosion and Sedimentation Controls;
- Operation and Maintenance of Erosion and Sedimentation Controls;
- Inspection Schedule;
- Maintenance Schedule;
- Inspection and Maintenance Log Form.

Adverse impacts due to erosion, sedimentation, or both during disturbance and construction activities are prevented:

- With erosion and sediment controls that the Applicant will implemented and maintain (explain in Report narrative) **in narrative and on plans**
- Without erosion and sediment controls (explain in Report narrative)



TOWN OF BELMONT

Checklist for Stormwater Management and Erosion Control Report

- A Construction Period Pollution Prevention and Erosion and Sedimentation Control Plan containing the information set forth above has been included in the Stormwater Report.
- The project is highly complex and information is included in the Stormwater Report that explains why it is not possible to submit the Construction Period Pollution Prevention and Erosion and Sedimentation Control Plan with the application. A Construction Period Pollution Prevention and Erosion and Sedimentation Control has **not** been included in the Stormwater Report but will be submitted **before** land disturbance begins.
- The project is **not** covered by a NPDES Construction General Permit.
- The project is covered by a NPDES Construction General Permit and a copy of the SWPPP is in the Stormwater Report.
- The project is covered by a NPDES Construction General Permit but no SWPPP been submitted. The SWPPP will be submitted BEFORE land disturbance begins.

Standard 9: Operation and Maintenance Plan

- The Post Construction Operation and Maintenance Plan is included in the Stormwater Report and includes the following information:
 - Name of the stormwater management system owners;
 - Party responsible for operation and maintenance; **TBD**
 - Schedule for implementation of routine and non-routine maintenance tasks;
 - Plan showing the location of all stormwater BMPs maintenance access areas; **on design plans**
 - Description and delineation of public safety features; **N/A**
 - Estimated operation and maintenance budget; and **TBD**
 - Operation and Maintenance Log Form.
- The responsible party is **not** the owner of the parcel where the BMP is located and the Stormwater Report includes the following submissions:
 - A copy of the legal instrument (deed, homeowner's association, utility trust or other legal entity) that establishes the terms of and legal responsibility for the operation and maintenance of the project site stormwater BMPs;
 - A plan and easement deed that allows site access for the legal entity to operate and maintain BMP functions.

Standard 10: Prohibition of Illicit Discharges

- The Long-Term Pollution Prevention Plan includes measures to prevent illicit discharges;
- An Illicit Discharge Compliance Statement is attached;
- NO Illicit Discharge Compliance Statement is attached but will be submitted **prior to** the discharge of any stormwater to post-construction BMPs.